



For Sales Enquiry :

Gujarat	+91 6352597984 / + 91 9909929920
Mumbai	+91 90161 12641
Rest Of Maharastra	+91 90161 13906
Madhya Pradesh	+91 6352597920
Chhattisgarh	+91 9909958253
Karnataka	+91 8588855732
Tamil Nadu	+91 90161 13976
Andra Pradesh / Telangana	+91 9642000336
Kerala	+91 90161 12798
West Bangal	+91 8584065557
Odisha	+91 7861809594
Bihar	+91 7360042576
Jharkhand	+91 7360032634
North East	+91 9979991064
Rajasthan	+91 8008503660
Punjab	+91 9988222471
Chandigarh / Himachal Pradesh	+91 7984970615
Jammu & Kashmir	+91 6353351414
Haryana	+91 8588893441
Uttar Pradesh East	+91 9979991479
Dealhi / Uttarakhand / Uttar Pradesh West	+91 90161 11491



**Asian Granito India Ltd.**

Regd. & Corp. Office

202, Dev Arc, Opp. Iskcon Temple, S.G. Highway,  
Ahmedabad - 380 015, Gujarat, INDIA.

Phone: +91 79 66125500/698 | Fax: +91 79 66125600/66058672  
CIN: L17110GJ1995PLC027025

E-mail: [info@aglasiangranito.com](mailto:info@aglasiangranito.com) | Web: [www.aglasiangranito.com](http://www.aglasiangranito.com)

1800 123 3455  
Toll-free: Mon-Sat 10am-6pm

Follow Us:



Scan code to  
Download  
AGL Tiles App



Scan code to  
Download  
Catalogue



Scan to Find  
Exclusive  
Store



INSPIRED  
**CREATIONS**



1200x1800mm | 800x1600mm | 800x2400mm | 800x3000mm

## TRANSFORM SPACES WITH GRAND FORMATS OF LUXURY

AGL's MarbleX collection is truly exceptional, Boasting extraordinary magnificence and unparalleled features. With grand sizes ranging 800x3000mm, 800x2400mm, 1200x1800mm, and 800x1600mm. This collection is truly remarkable and incomparable.

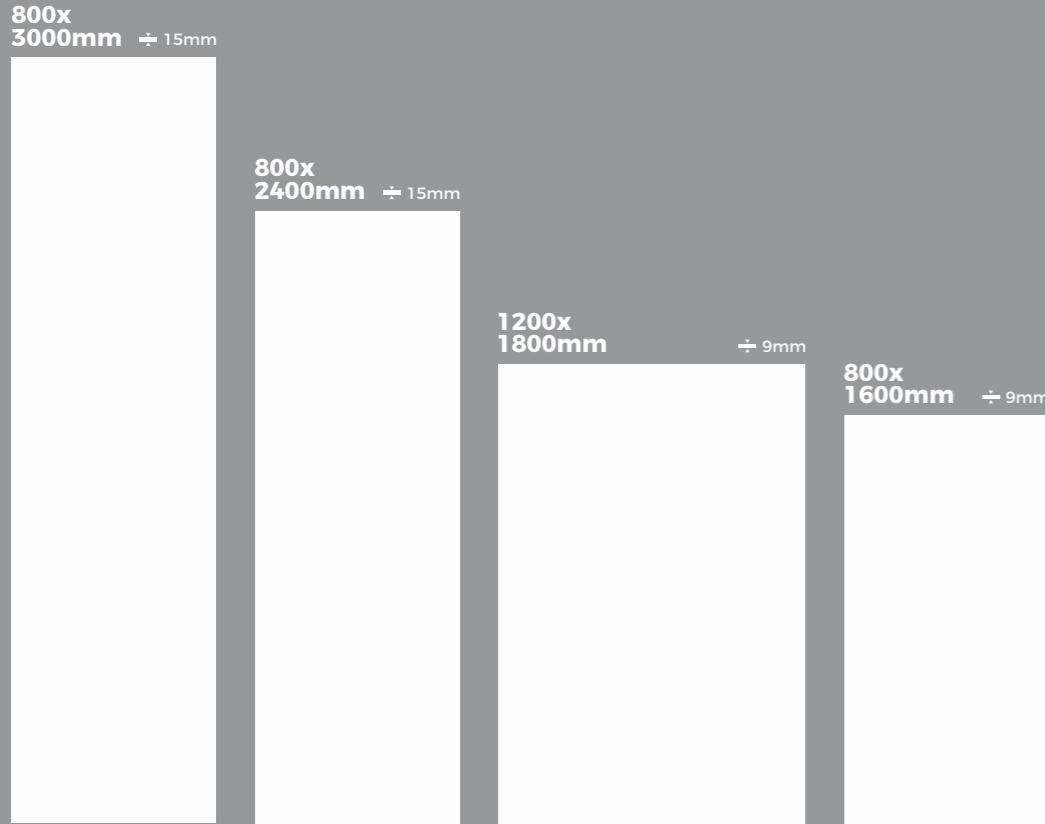

INIMITABLE ELEGANCE FOR REMARKABLE SPACES

## UNMATCHED STRENGTH & ELEGANCE

These surfaces provide an extra edge with feature-rich attributes like resistance to weather and chemicals, easy-to-clean and maintain, abrasion proof, stain and scratch resistant that do not require special care. Create your envisioned ambiance for a hassle-free lifestyle.

### TECHNICAL FEATURES



Scratch and Abrasion Resistant



Resistant to UV Rays



Easy to Clean Surface



Resistant to Fire and Heat



Frost Resistant Surface



Flatness and Stability Over Time



Impact Resistant Surface



Water Resistant Surface



Stain Resistant Surface



Hygienic and Suitable for Contact with Food



Resistant to Chemicals, Acids, Bases, and Solvents



Resistant to Mould, Mildew, and Fungus

## COMPANY STRENGTH



**54.5 Million Sq.Mtr.**

Production Capacity Per Annum\*\*



**Consolidated Net Turnover**

**₹ 1562cr.**  
(US \$190 million)



**1400+** Designs



**30+** Different Sizes



**12** Display Centres



**6000+** Employees\*

\* Includes contract labour



**14** Mfg. units



Exports in **100+** Countries



**Trade Network** in **35** States & UTs of India



**200+** Showrooms



**11+** Digital Printing Technology



**First to bring** world's largest 5 line kiln set up in India



**1.4 Million+** Facebook Followers



**6500+** Touch Point

\*\* including JVs

## Manufacturing through latest technologies and systems.



**Asian Granito India Limited** has debunked the myth that leadership in design is a forte only of foreign players by achieving the position through an ideal mix of creativity and technology. It has been the champion in introducing innovative digital printing technology with a technical collaboration with SACMI, Italy. A world-class Quality Management System has enabled us to build a portfolio that is truly avant-garde.

## VERSATILE APPLICATIONS THAT TRAVERSE TIME TO ESTABLISH TRENDS

Crafted to express creativity, the MarbleX Collection is perfect when it comes to giving a touch of class to your spaces with the added advantage of timeless appeal that never ceases to amaze. With multiple application possibilities – both indoors and outdoors, these surfaces are architectural gems that can be used across a gamut of environs.



WALL & FLOOR CLADDING



COMMERCIAL SPACE & RETAIL DISPLAYS



KITCHEN BACKSPASHES, COUNTER TOPS

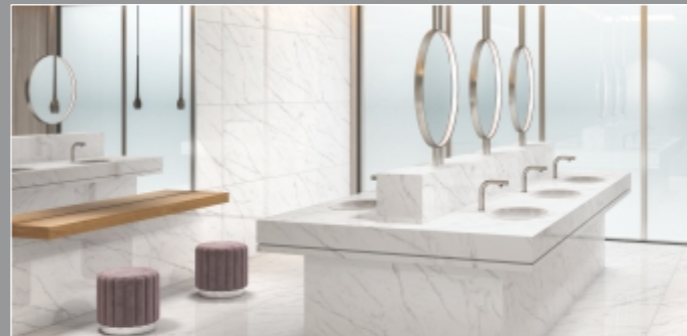

BATHROOM WALL & FLOOR, VANITY TOPS



FIREPLACE SURROUNDS



STAIRCASE TREADS AND RISERS

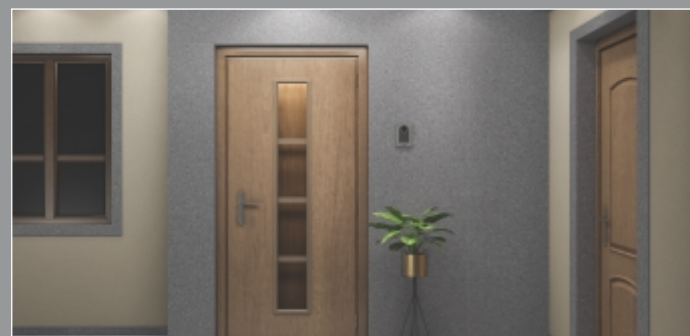

DOOR & WINDOWSILLS



FURNITURES

## INDEX

### Product Details

### Page No.

#### 1200x1800mm

• IRIDIUM .....	06-07
• VELVET .....	08-09
• HIGH GLOSS .....	09
• POLISH .....	10-14
• MANTECA (MATT) .....	15

#### 800x1600mm

• IRIDIUM / SATIN .....	16
• CARVING / CARVING MULTI COLOUR .....	17-18
• HIGH GLOSS .....	19
• INFINITY POLISH .....	20
• POLISH .....	21-25
• FULL BODY POLISH / MATT .....	26

#### 800x2400mm

• FULL BODY POLISH / MATT (GRANITI SERIES) .....	27-28
• FULL BODY POLISH (MAGIC SERIES) .....	29-30
• FULL BODY POLISH (DOLCE SERIES) .....	31
• FULL BODY POLISH / MATT (PLAIN COLOR & FLAKES) .....	32
• GLAZED BODY POLISH .....	33
• CARVING .....	34
• HIGH GLOSS (PRINTED) .....	35-36
• POLISH (PRINTED) .....	37-38
• MANTECA (MATT) (PRINTED) .....	39

#### 800x3000mm

• FULL BODY POLISH (SIETE SERIES) .....	40-42
• FULL BODY POLISH / MATT (CENTEZZA SERIES) .....	43-44
• FULL BODY POLISH (PLAIN COLOR) .....	45
• GLAZED BODY POLISH .....	46
• POLISH (PRINTED) .....	47
• MANTECA (MATT) .....	48-49

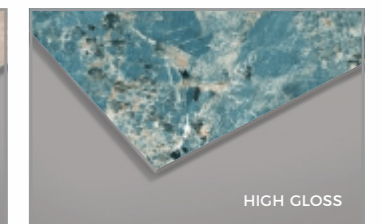
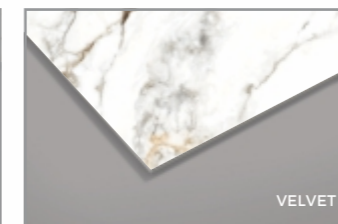
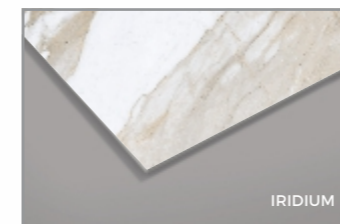

#### Introducing new finish :

**IRIDIUM** : The primary distinguishing feature of Iridium Finish Tiles is their steel-like appearance. They mimic the texture, shine, and color of steel, which adds a modern and industrial touch to spaces. This aesthetic makes them a popular choice for contemporary interior designs.

**VELVET** : Velvet Finish tiles is their exceptionally smooth and tactile surface. They mimic the feel and appearance of velvet fabric, creating a sense of luxury and opulence in interior spaces. The tiles are available in various colors and shades, allowing for customization in design projects.

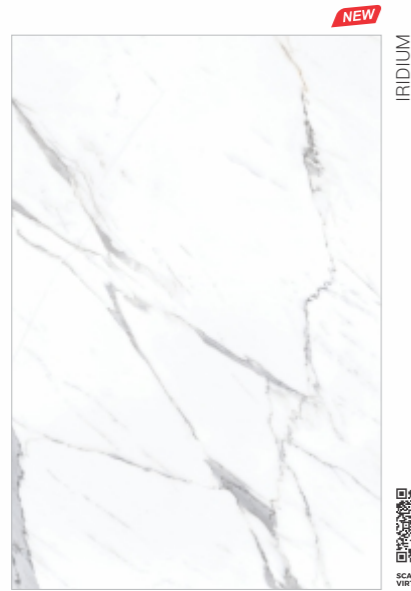

IRIDIUM SANA SUPREME

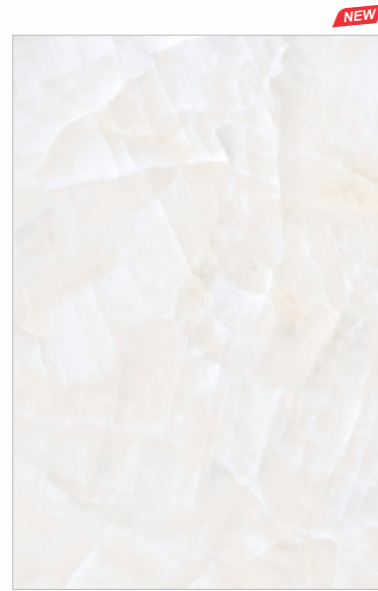

IRIDIUM GARNET SKY

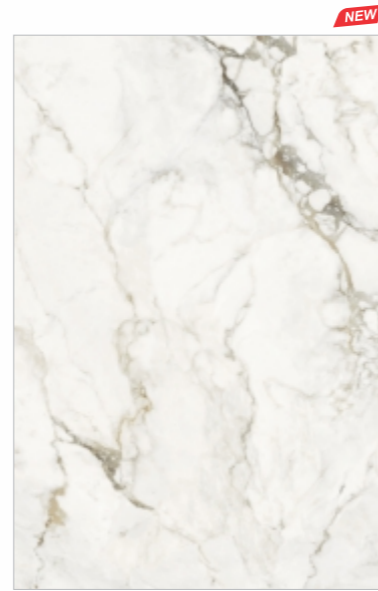

IRIDIUM HOLLAND ICE



BATHROOM WALL & FLOOR - IRIDIUM SANA SUPREME



IRIDIUM THORN WHITE



KITCHEN ISLAND, WALL & FLOOR - IRIDIUM THORN WHITE

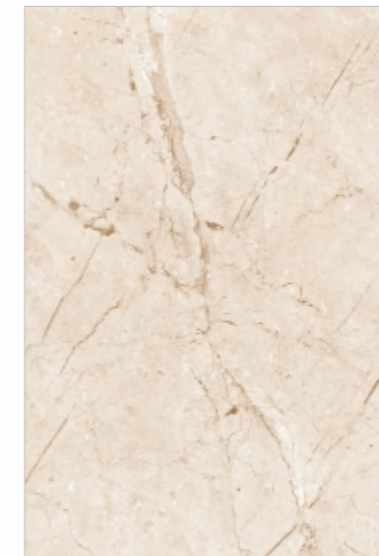

IRIDIUM KAMPALY IVORY

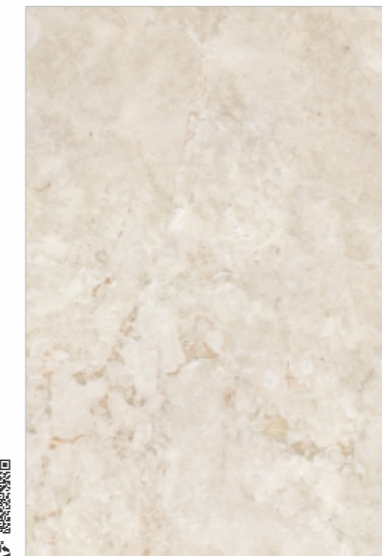

IRIDIUM FRIESLAND SILK



IRIDIUM BELGIUM ROSSATA



IRIDIUM DUBBO BEIGE

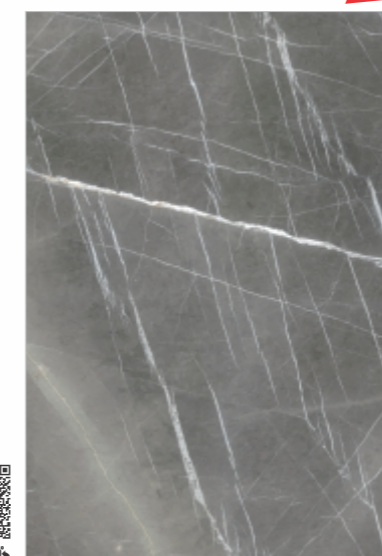

IRIDIUM ARUBA ARMANI

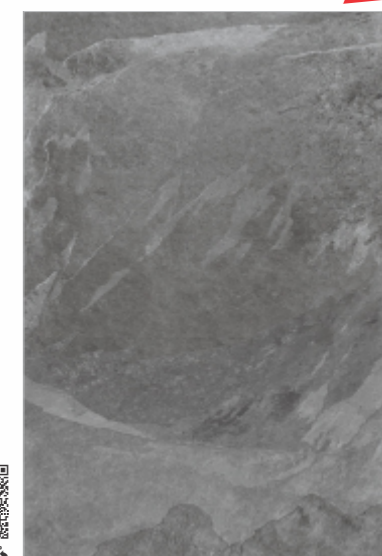

IRIDIUM GEXO STEEL



VELVET DACIO BIANCO

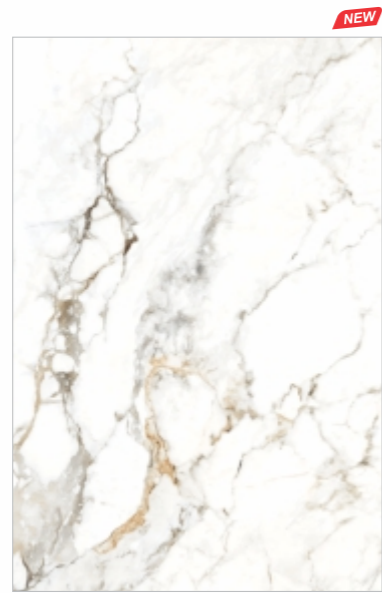

VELVET AUSTIS BRONZE

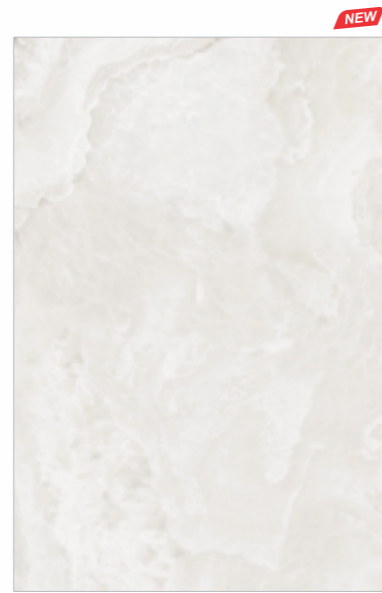

VELVET GRESSO ONYX PEARL

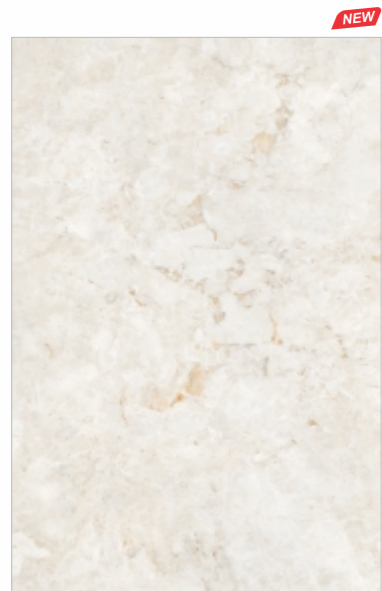

VELVET RIMINI TAUPE



VELVET AZZATE BEIGE



VELVET ORTE BEIGE



WALL & FLOOR  
VELVET RIMINI TAUPE

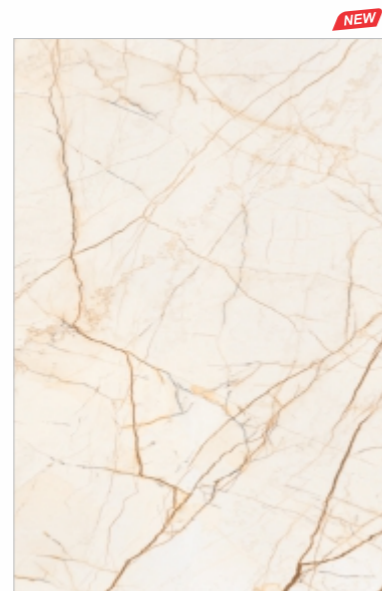

VELVET SPIDER CREMA



VELVET SLOTEN CREMA

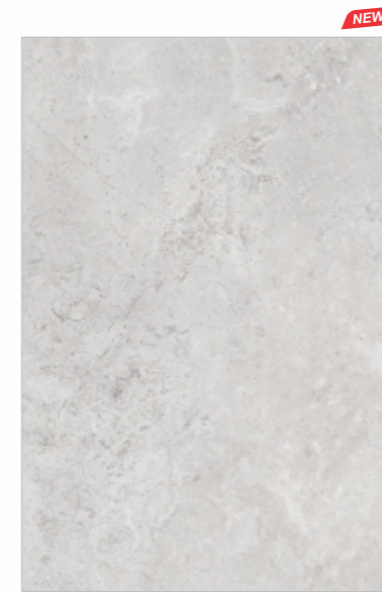

VELVET ELICE BIANCO



VELVET FARAYA BONE

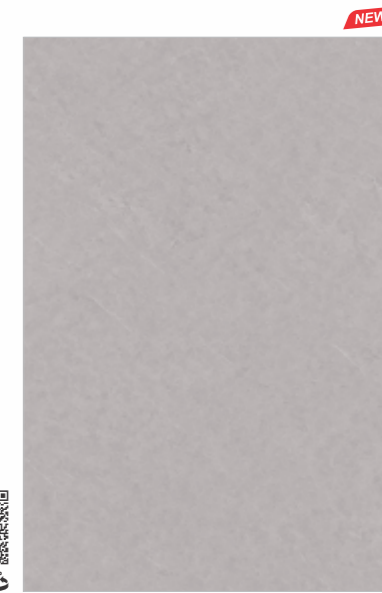

VELVET EMILY GRIS



WALL : GLITZ GEMELLI BROWN

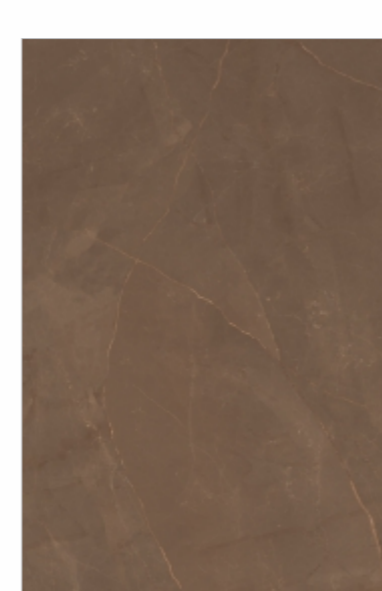

ROYAL ARMANI BRONZE

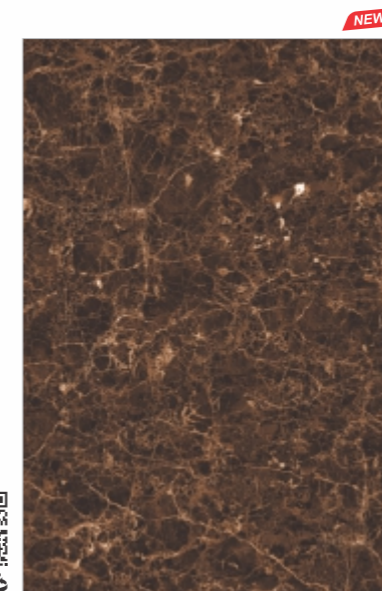

GLITZ GEMELLI BROWN



POLISH



STATUARIO NUOVA



ROYAL SATVARIO



NEW



CUMANA SATVARIO FP



NEW



DACIO BIANCO FP

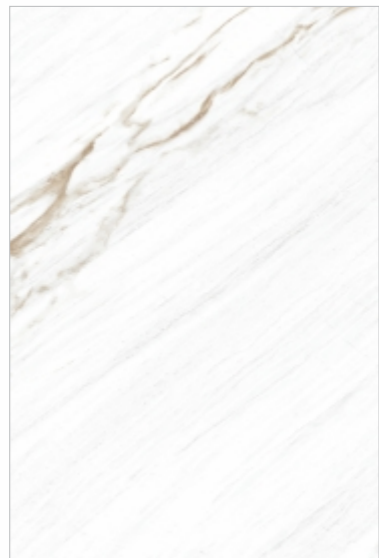

MICHAEL ANGELO ROCIO

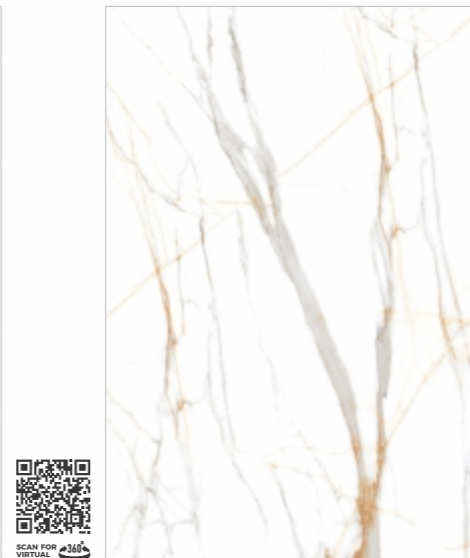

CALCUTTA ORO



FLOOR - CUMANA SATVARIO FP

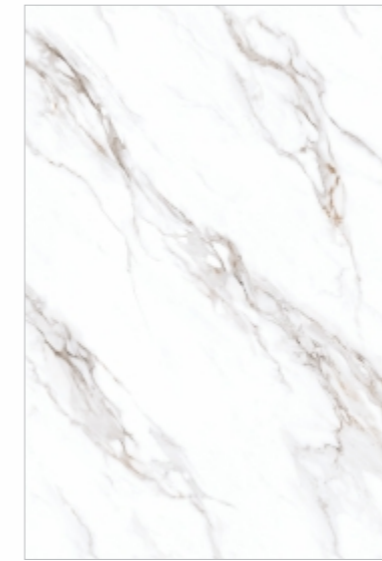

POLISH



DIA SUNSHINE BIANCO FP

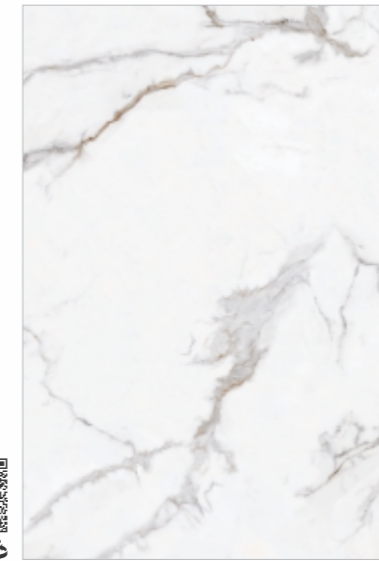

NEW



ELIGHT WHITE FP



NEW



CIARA GOLD FP

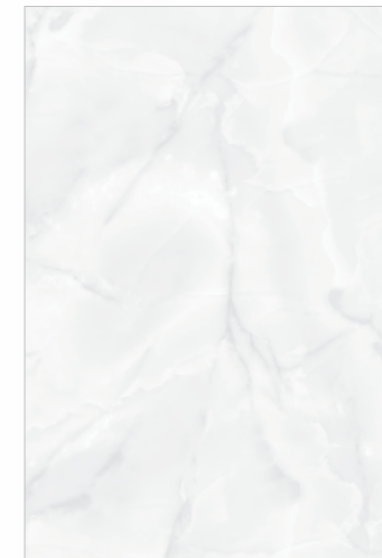

HAZEL ONYX

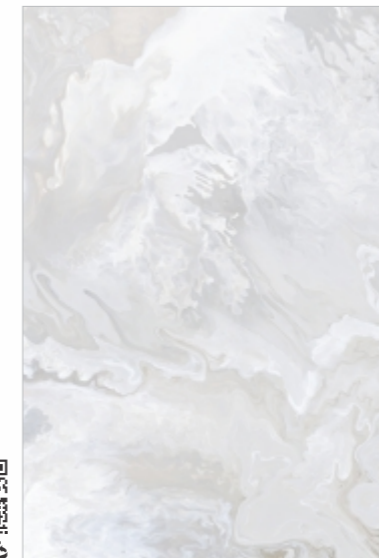

FLUID ONYX

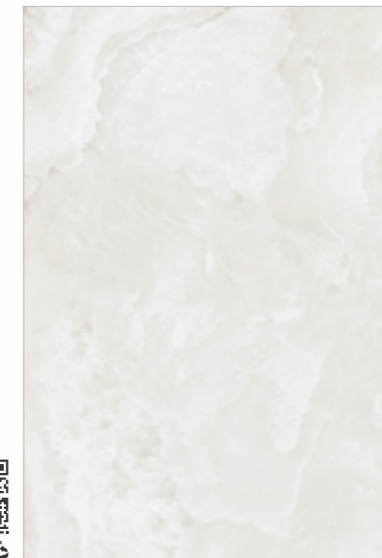

NEW



GESSO ONYX PEARL FP

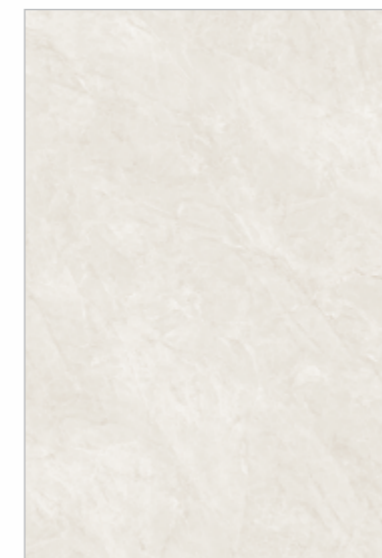

EVITA MARFIL

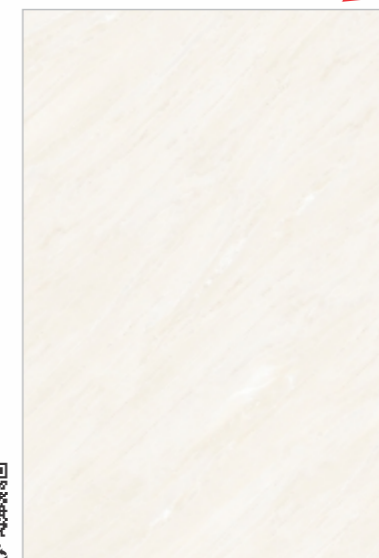

NEW



CITEINE CREMA FP

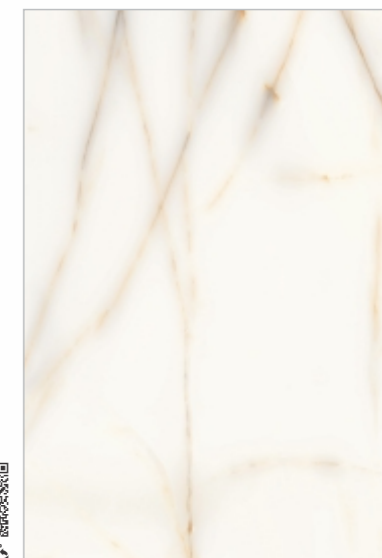

NORA ONYX



ISABEL BIANCO DEVON BEIGE FP DELICATA BOTTOCINO CREMA FP



MARFIL CREMA CITADEL BEIGE EMMA CREMA FP



ETNA BOTTOCINO CREMA FP ENIGMA CREMA FP MEGAN CREMA

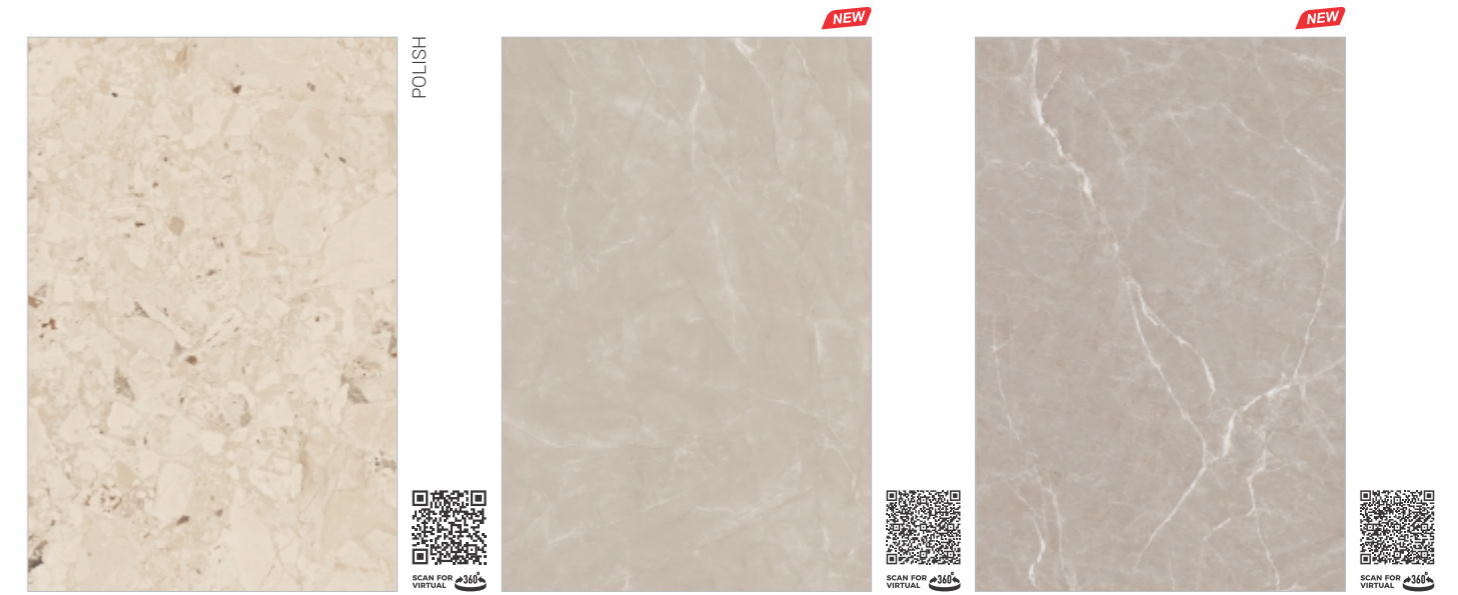

ESCAMAS BEIGE CHICAGO CREMA FP ETON GREAK FP

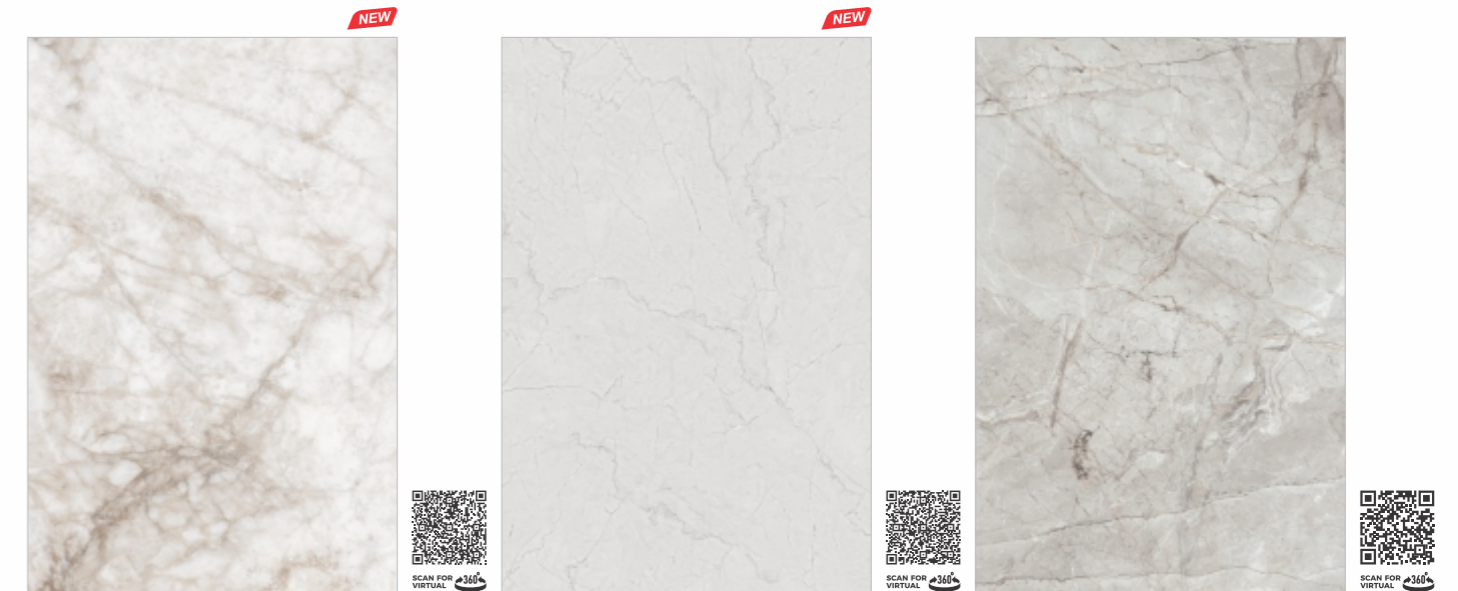

FIDENZA ICE FP DELICATA BOTTOCINO GREY FP RADICE GRIS



FLOOR - FIDENZA ICE FP



FARAYA GREY FP

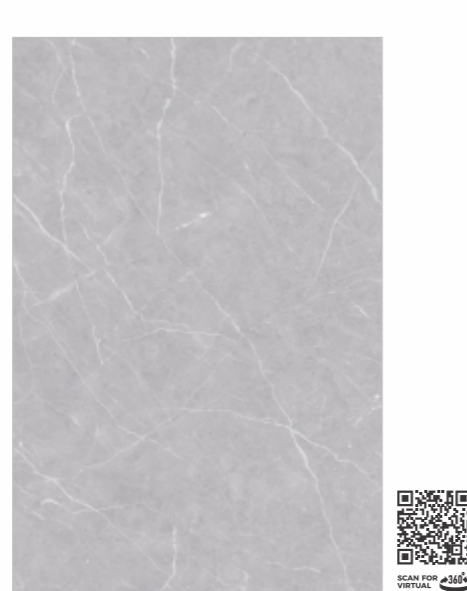

AMEXA GRIS

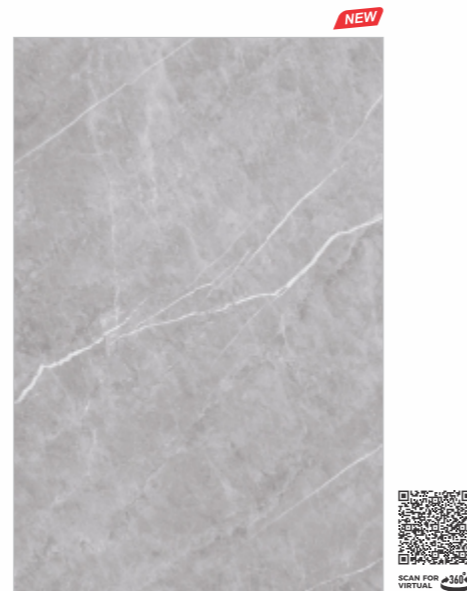

ALITIA GREY FP



EMILY GREY FP

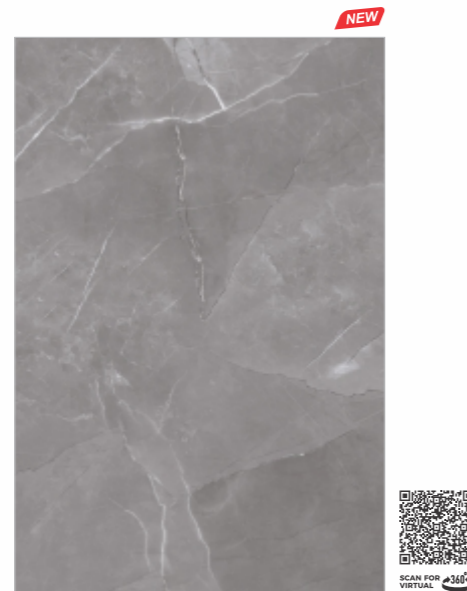

DUERO GRIS FP

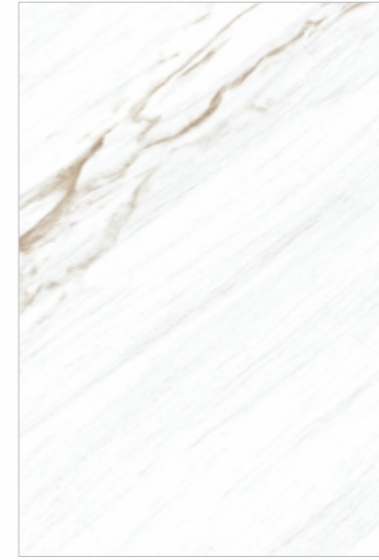

MICHAEL ANGELO GRIGIO

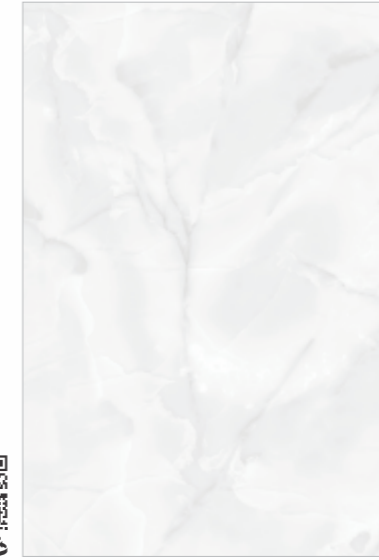

ONYX NYLE



BLAIR GRIS

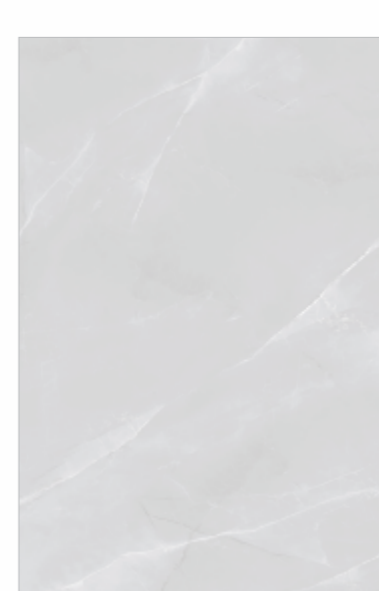

CLORA GRIS

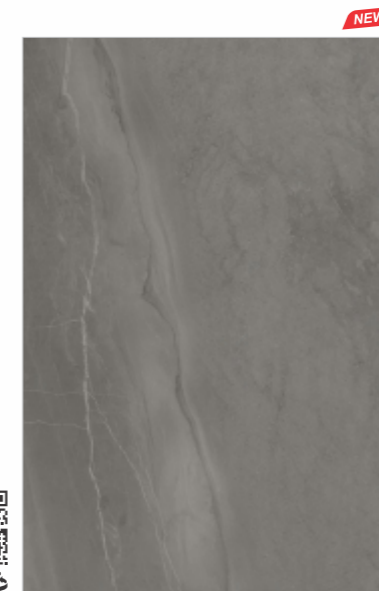

MANTECA ESHANA OLIVE

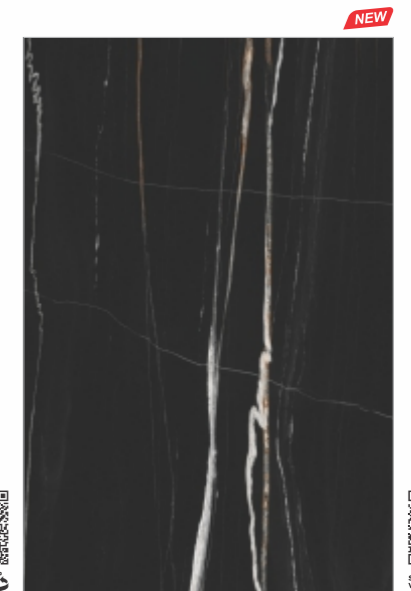

MANTECA ICONA NOIR

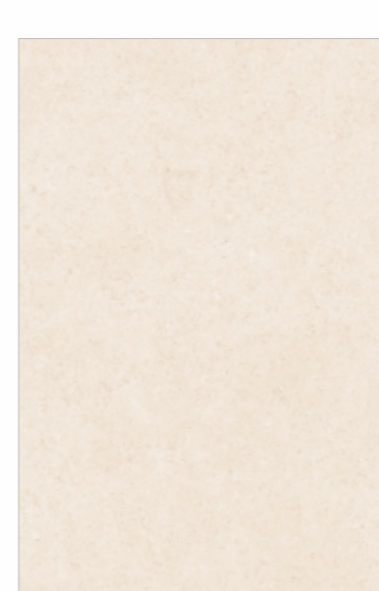

EVA CREMA

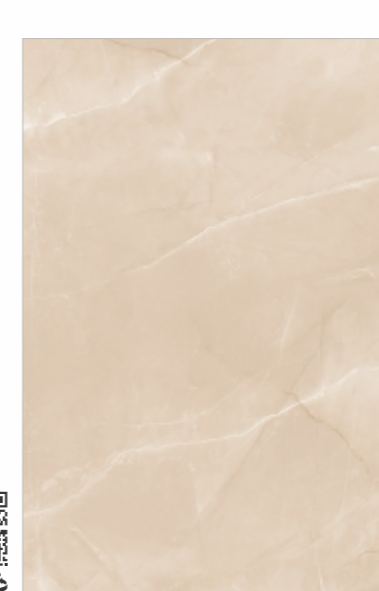

CLORA CREMA



KYLA BEIGE

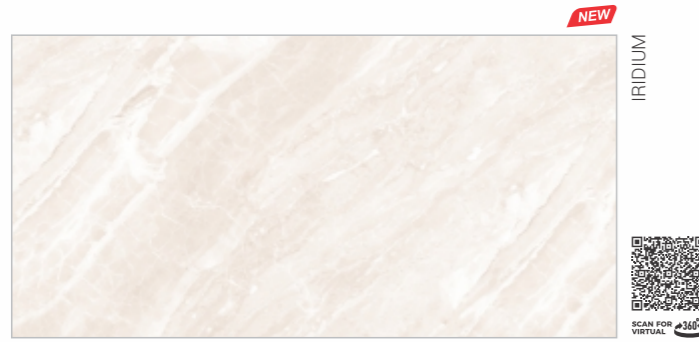

IRIDIUM AROMA BEIGE

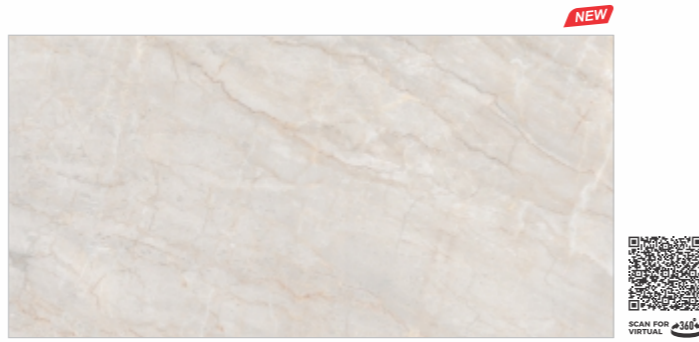

IRIDIUM ARIANA IVORY



IRIDIUM TORRETO GREY



IRIDIUM VENICE ORO



IRIDIUM ALVIRA BIANCO

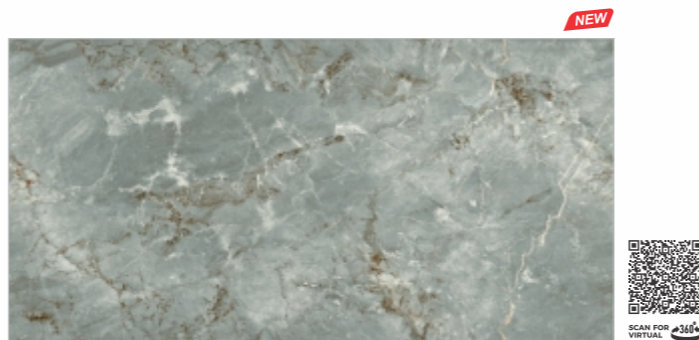

IRIDIUM VIGASIO BLUE

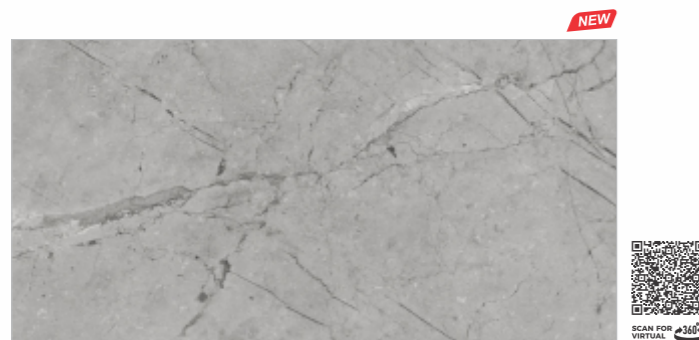

IRIDIUM ALLURE GREY

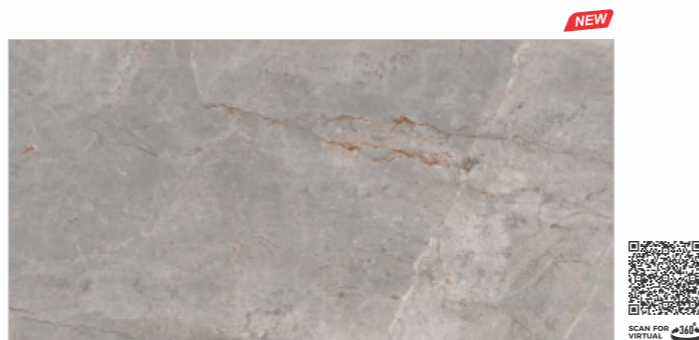

IRIDIUM LAURINO GRIS



FLOOR - SILK FLORITO

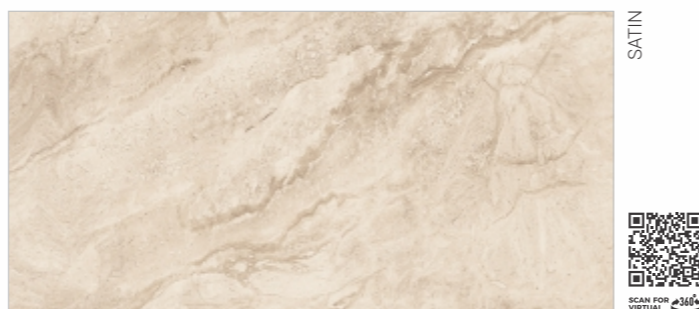

SILK FLORITO



CONVERSE WHITE

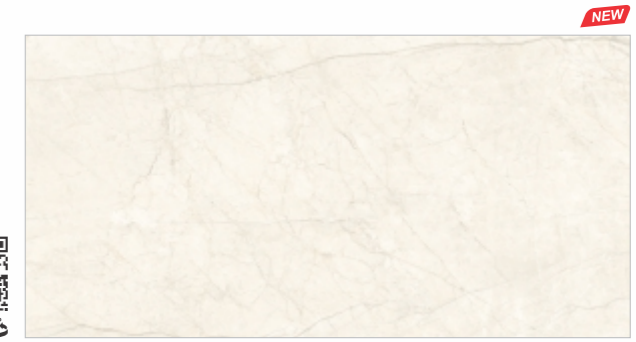

OPULENCE ALVA IVORY



WALL & FLOOR - OPULENCE VIGASIO AQUA



LITE BOTTOCHINO CREMA

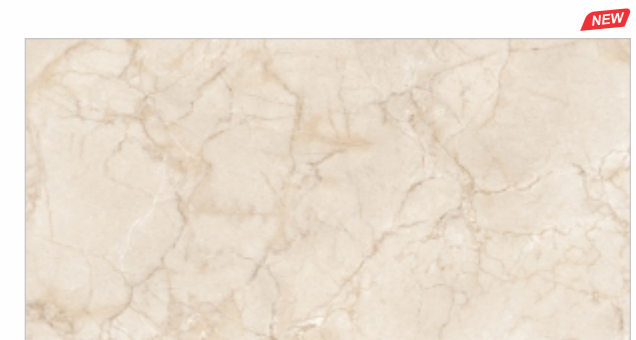

OPULENCE AINA BEIGE

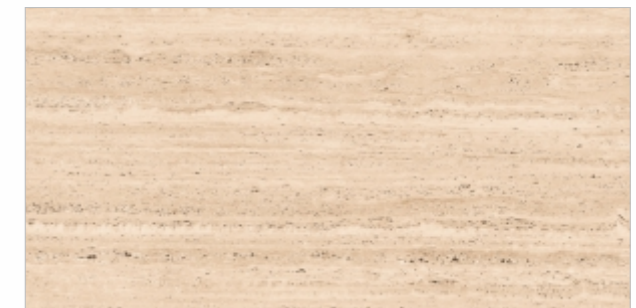

TRAVERTINE BEIGE

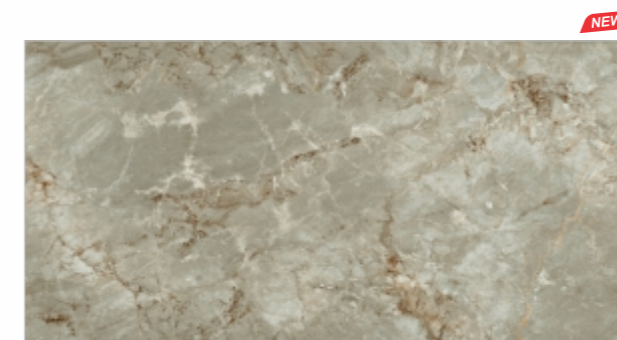

OPULENCE VIGASIO AQUA

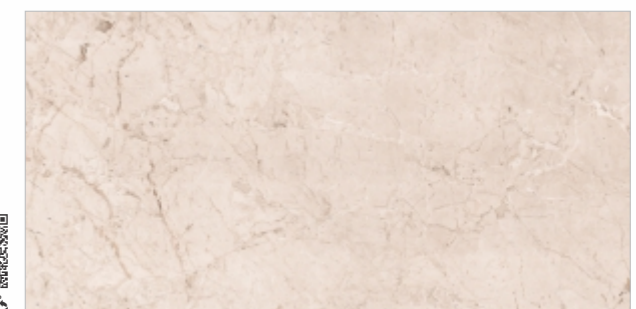

SOFITA BEIGE

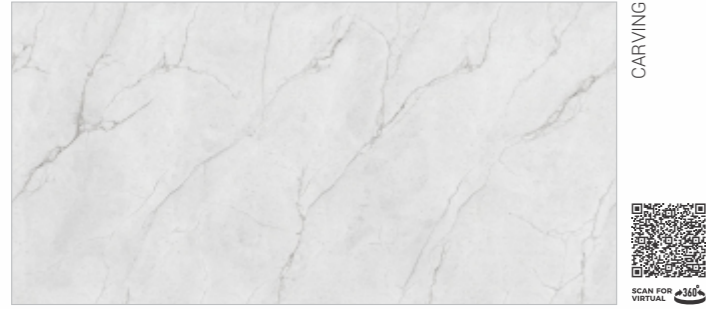

VENUS GRIS

CARVING



URBEN STEEL



OPULENCE CASINA STATUARIO

NEW

CARVING MULTI COLOUR



OPULENCE CASINA STATUARIO LINER

NEW

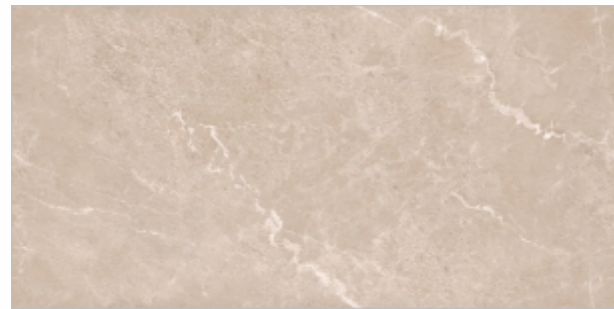

OPULENCE BRENTA CREMA

NEW



OPULENCE BRENTA CREMA LINER

NEW



OPULENCE BRENTA SILVER

NEW



OPULENCE BRENTA SILVER LINER

NEW



OPULENCE BRENTA GREY

NEW



OPULENCE BRENTA GREY LINER

NEW

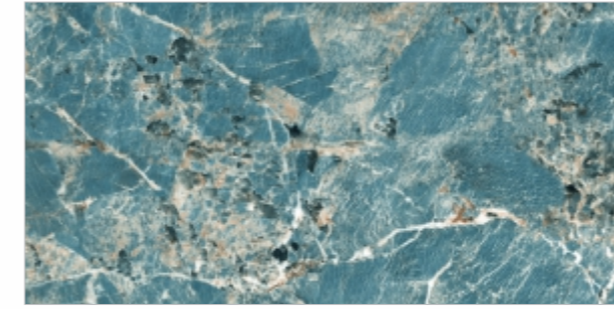

GLITZ ROMENO BLISS

NEW

HIGH GLOSS

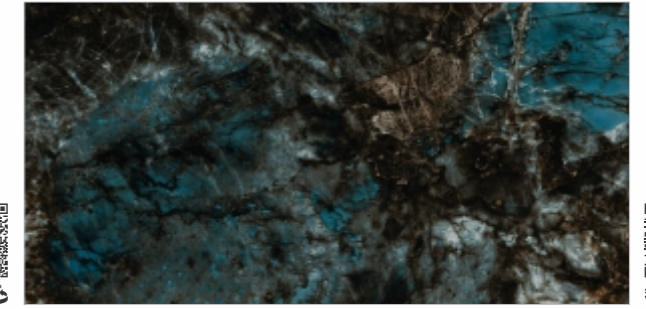

GLITZ MERANO AQUA

NEW



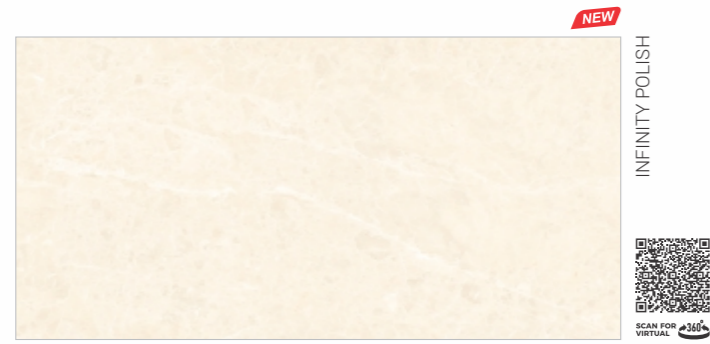

AYLA CREMA FP

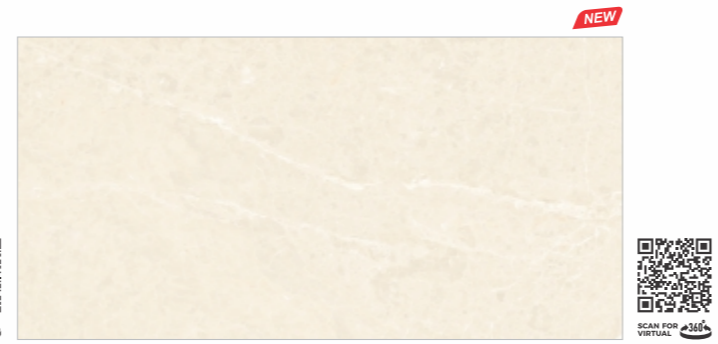

EMPERIO CREMA

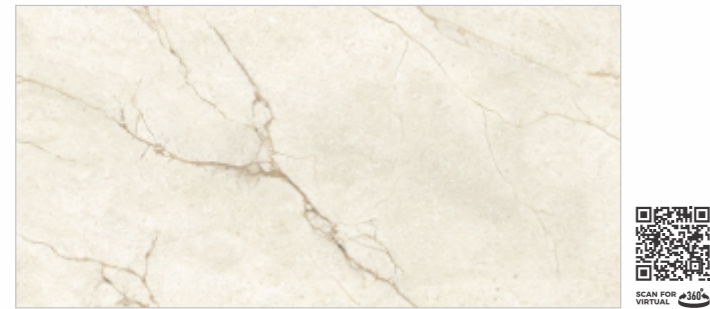

RIVER BEIGE

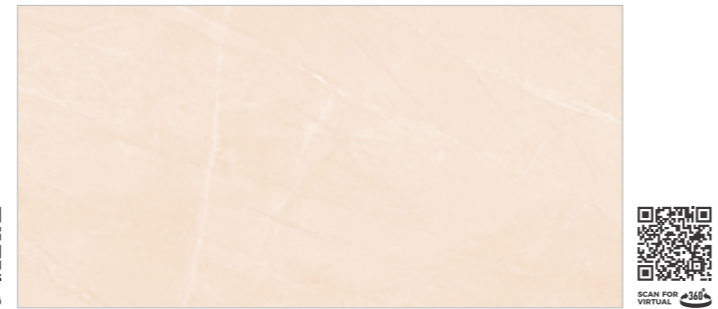

ARMENIA CREMA

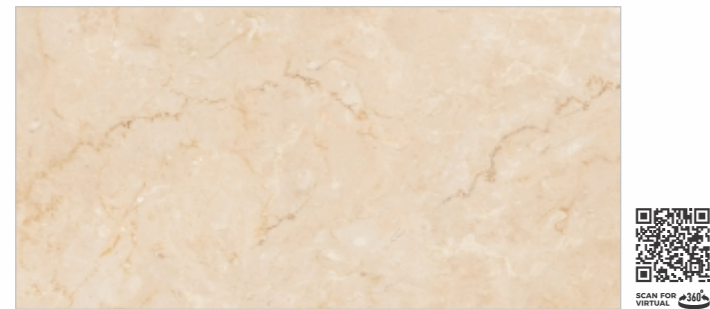

BOTTOLIN BEIGE

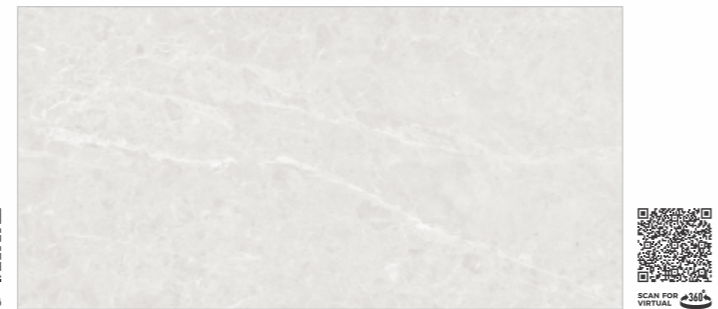

AYLA LIGHT GRIS FP

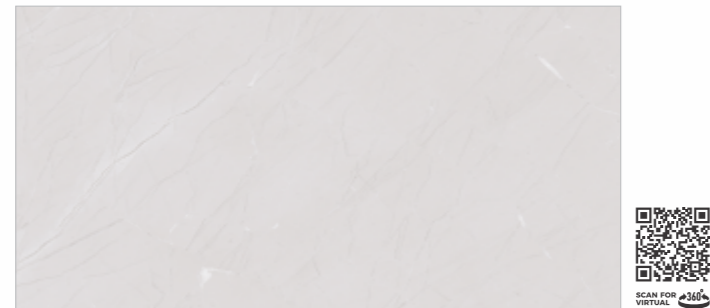

LAPIDA BIANCO

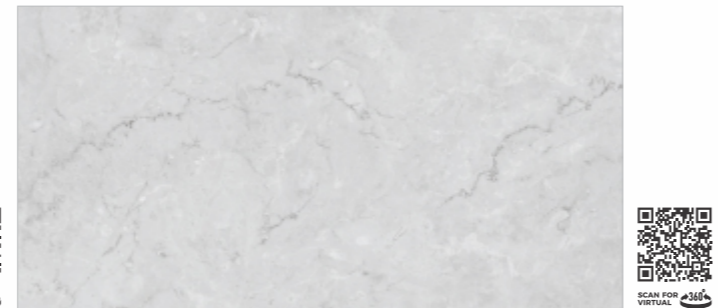

BOTTOLIN GREY



BETTY GRIS FP



ALPI SUPREMO FP

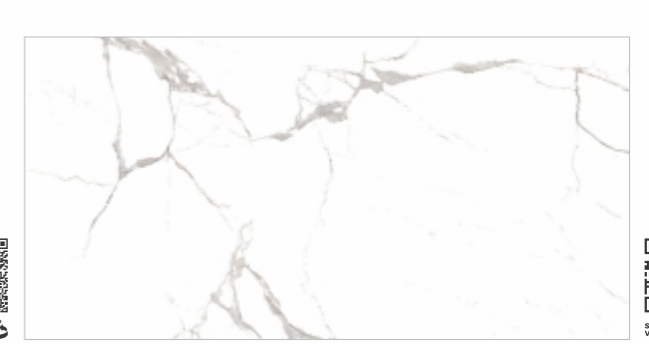

CLASSIC CALACATTA



PRO STATUARIO BIANCO

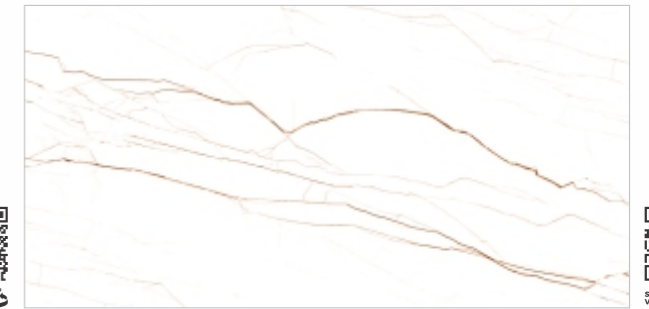

EXOTIC CREMA FP

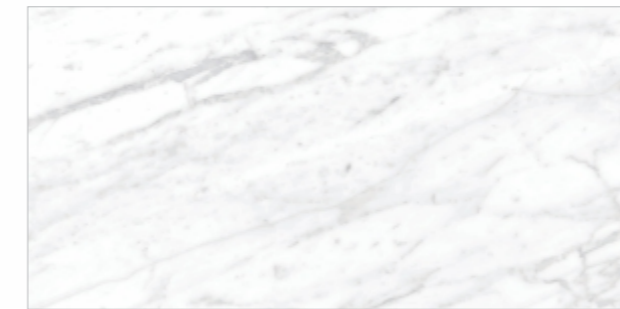

CARRARA SIA

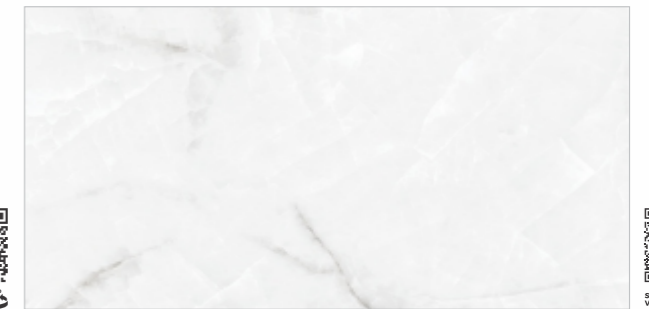

ATLAS PEARL FP



WALL & FLOOR - ALPI SUPREMO FP

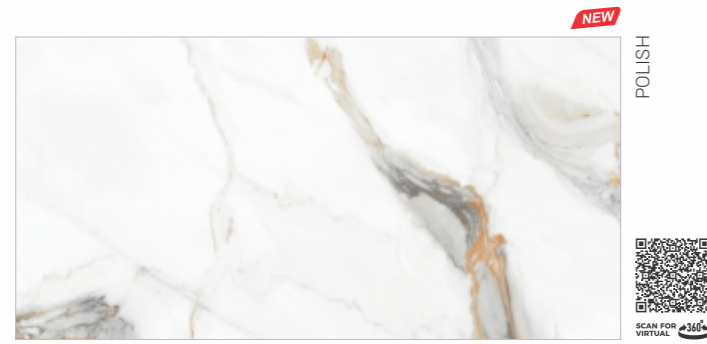

AURIC GLORY FP

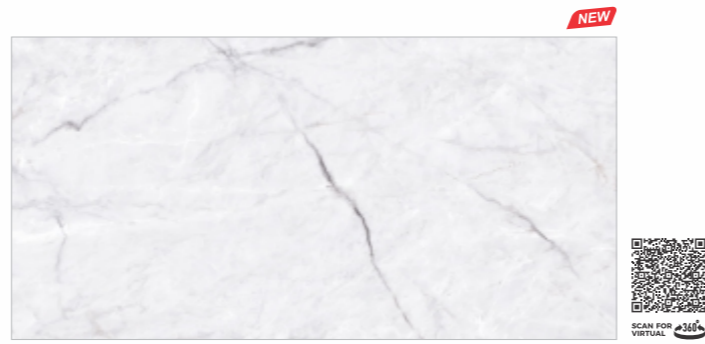

BIANCO FANTASTICO FP

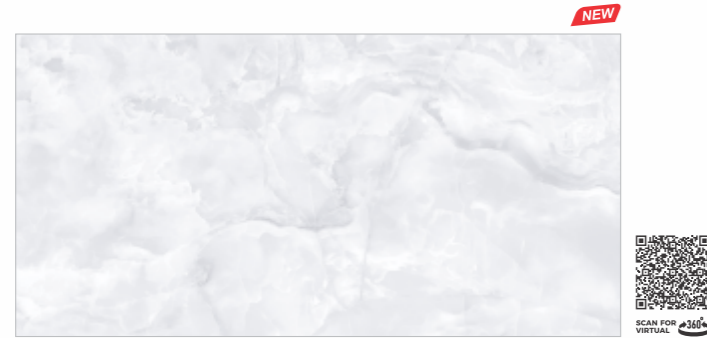

AZUMA CLOUD FP

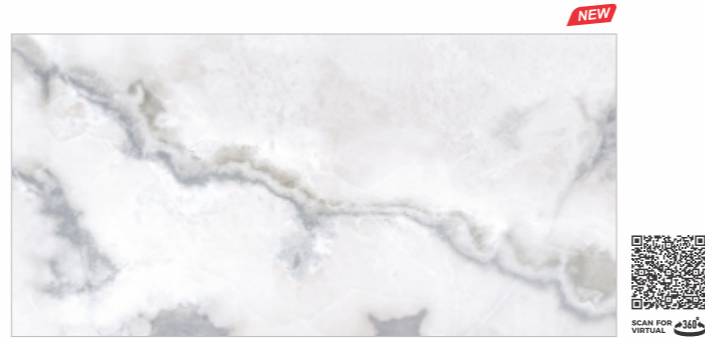

BLOX KNIGHT FP

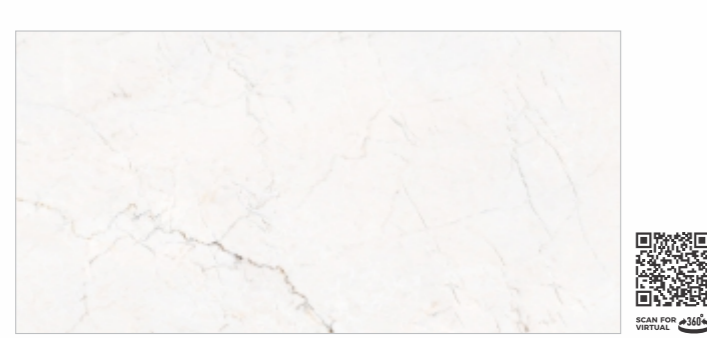

SENSO WHITE

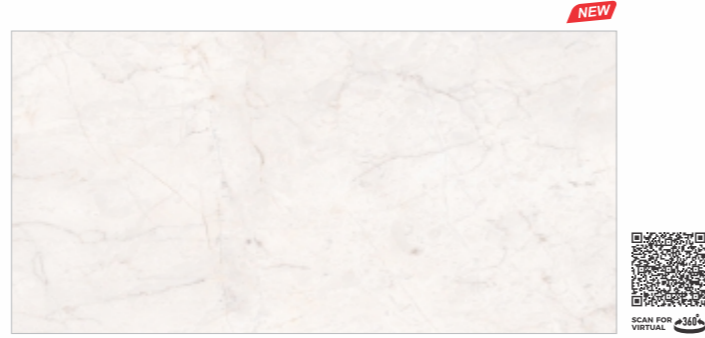

BLAZE BIANCO FP

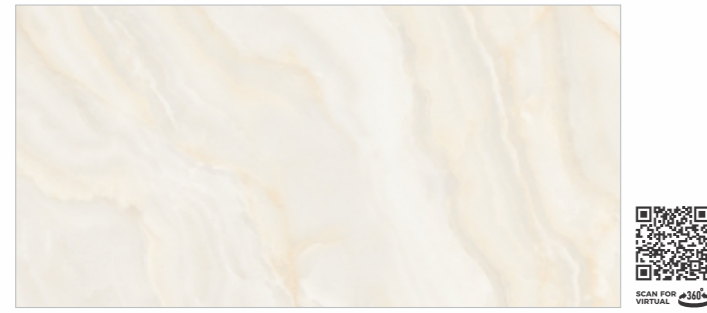

ROYAL ONYX



SUPREME ONYX

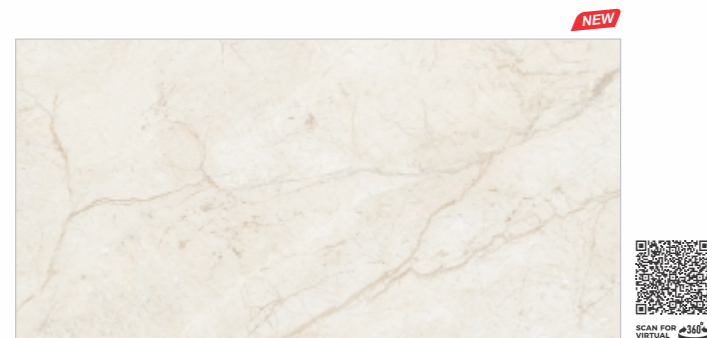

BAYA CREMA FP

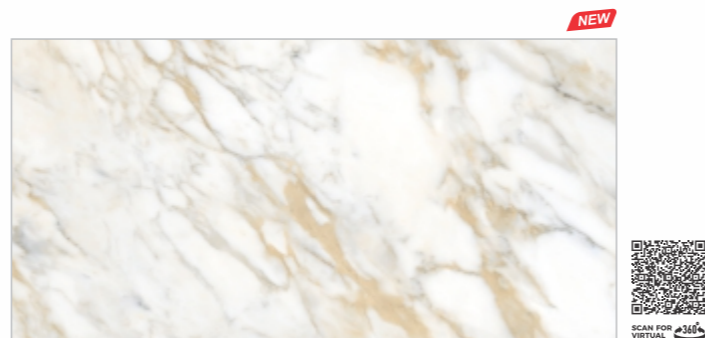

BILANCIA BRONZE FP



ARMANI CREMA FP

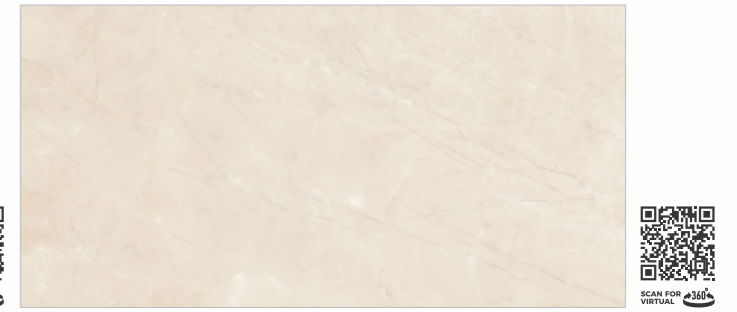

NORDIC BEIGE

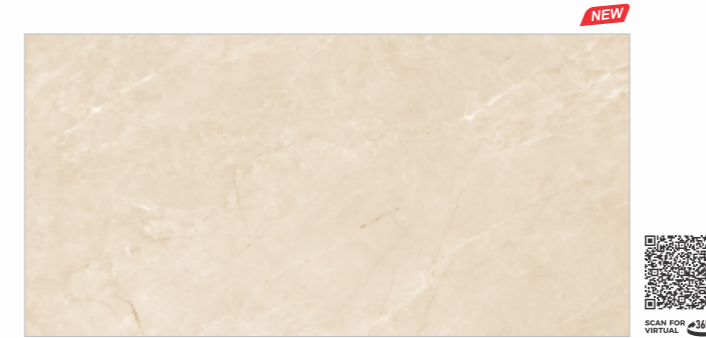

ORNICA CREMA FP

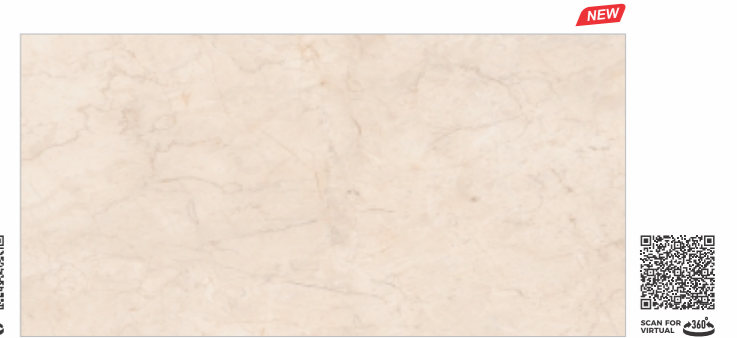

BLAZE MARFIL FP

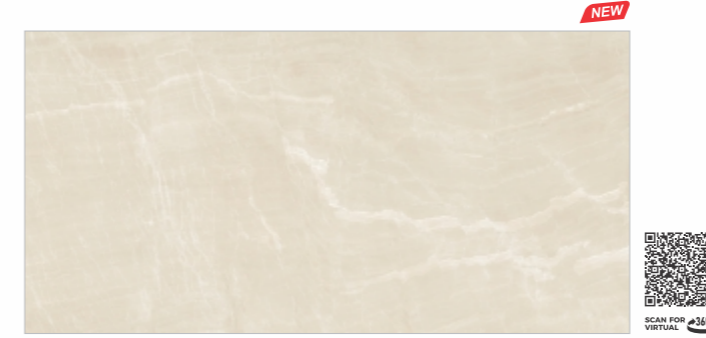

BOHARS BEIGE FP



ARTY IVORY FP





POLISH



SCAN FOR VIRTUAL



NEW



SCAN FOR VIRTUAL

BRECCIA AURORA FP

AVANI BEIGE FP



SCAN FOR VIRTUAL

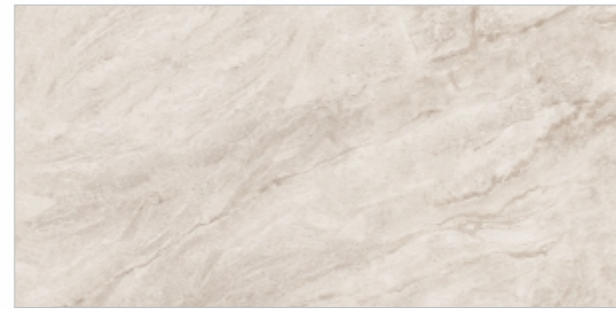

SCAN FOR VIRTUAL

DAINO BEIGE

FLORITO

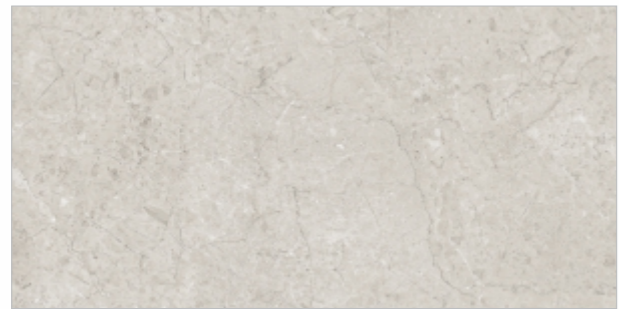

NEW



SCAN FOR VIRTUAL



NEW



SCAN FOR VIRTUAL

AVANI BIANCO FP

AVA TAUPE FP



FLOOR - BRECCIA AURORA FP

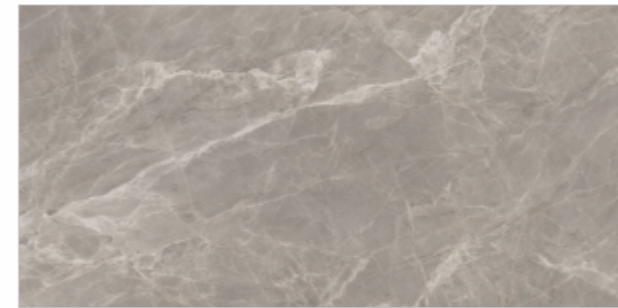

NEW

POLISH



SCAN FOR VIRTUAL

ALTINO CEMENTO FP



SCAN FOR VIRTUAL

RIVIERA NATURAL



NEW



SCAN FOR VIRTUAL

BELFAST GRIS FP



SCAN FOR VIRTUAL

INDUS GRIS

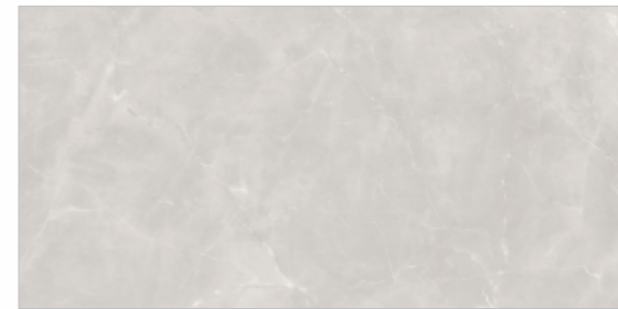

SCAN FOR VIRTUAL

ARMANI GRIS FP



SCAN FOR VIRTUAL

NORDIC GRIS



NEW



SCAN FOR VIRTUAL

BARCELONA GRIS FP

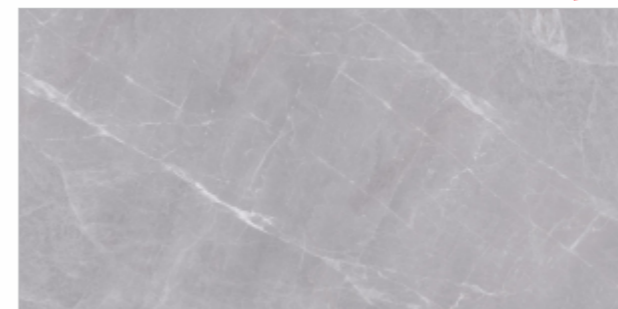

NEW



SCAN FOR VIRTUAL

AVA GRIS FP



WALL - NORDIC GRIS



RIMINI BIANCO



RIMINI CREAMA



RIMINI DOVE GREY

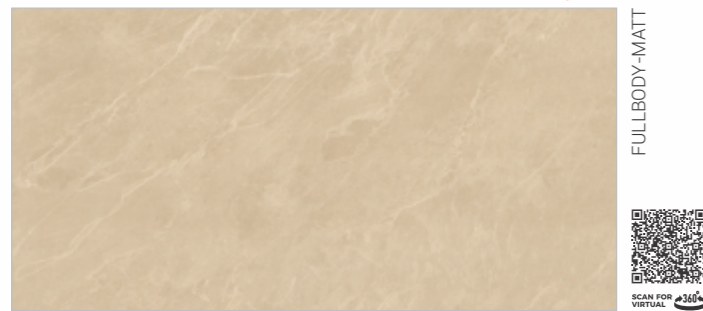

FB ANCONA BEIGE

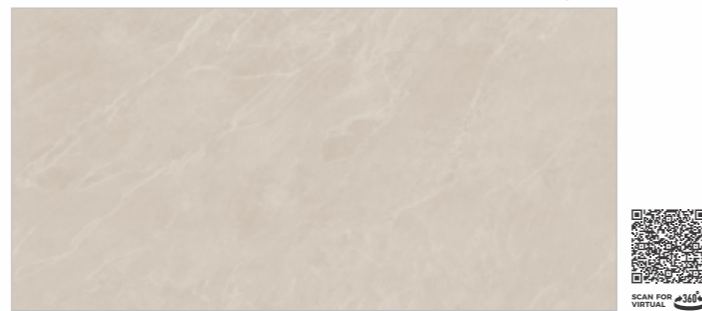

FB ANCONA SILVER



POOL AREA - FB ANCONA BEIGE



FB ANCONA GIRGIO

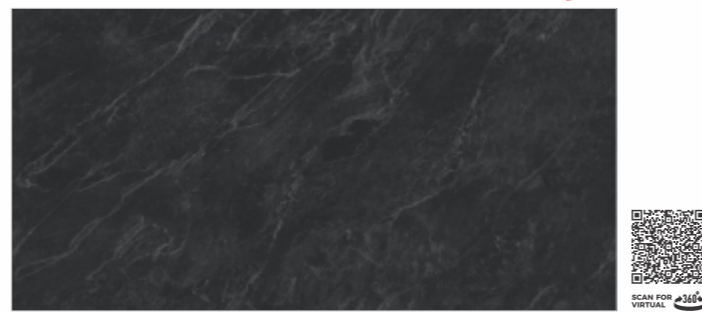

FB ANCONA NERO



GRANITI BIANCO (Polish) | ROCK GRANITI BIANCO (Matt)



GRANITI TAUPE (Polish) | ROCK GRANITI TAUPE (Matt)



KITCHEN ISLAND - GRANITI TAUPE



FULLBODY



GRANITI CREAMA (Polish) | ROCK GRANITI CREAMA (Matt)

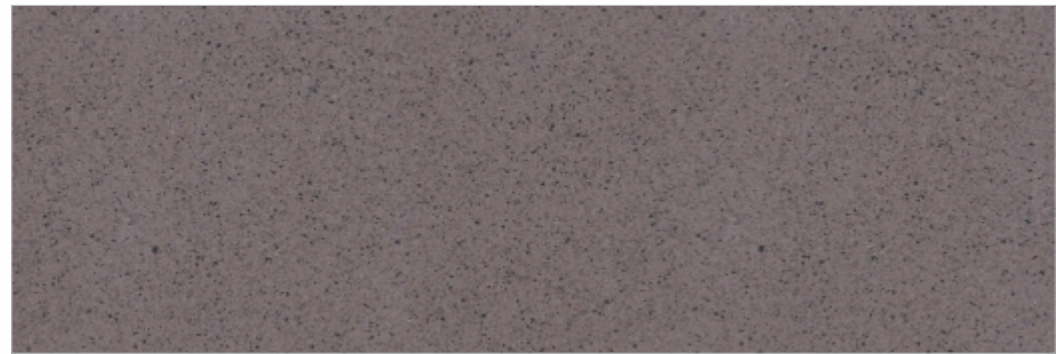

FULLBODY



GRANITI BROWN (Polish) | ROCK GRANITI BROWN (Matt)

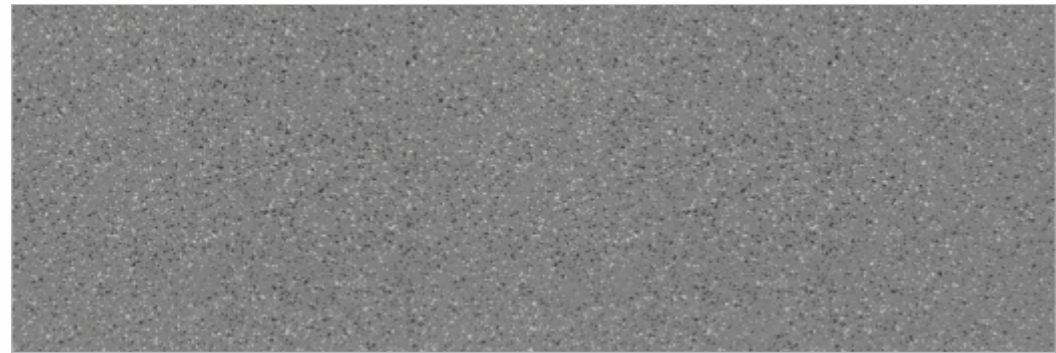

FULLBODY



GRANITI GRIS (Polish) | ROCK GRANITI GRIS (Matt)

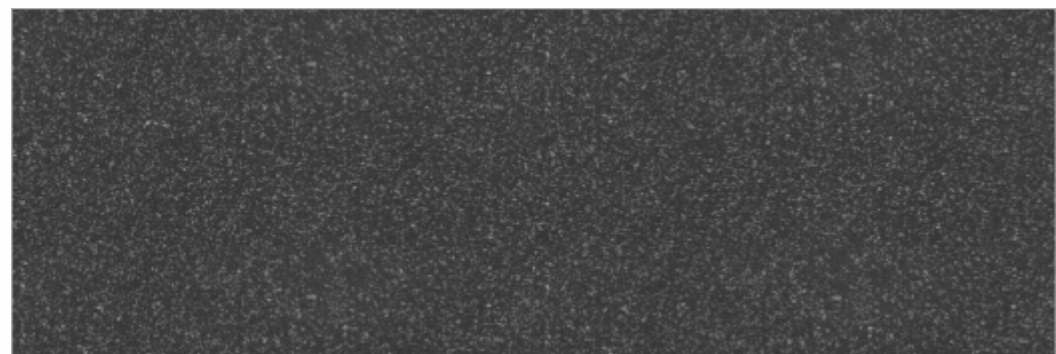

FULLBODY



GRANITI NERO (Polish) | ROCK GRANITI NERO (Matt)

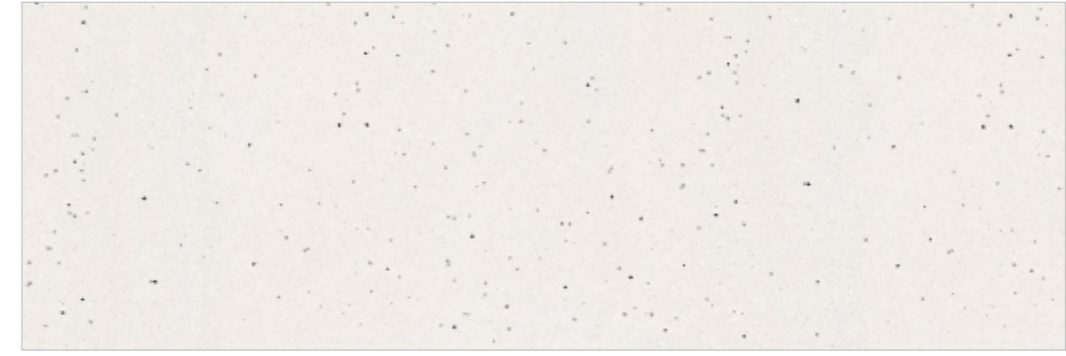

NEW

FULLBODY



MAGIC BIANCO (Polish)

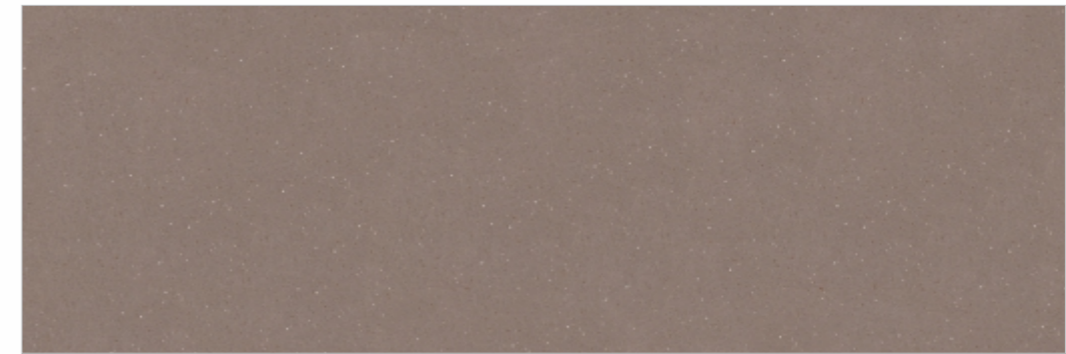

NEW

FULLBODY



MAGIC TAUPE (Polish)



KITCHEN COUNTER TOP - MAGIC BIANCO



MAGIC CREAMA  
(Polish)

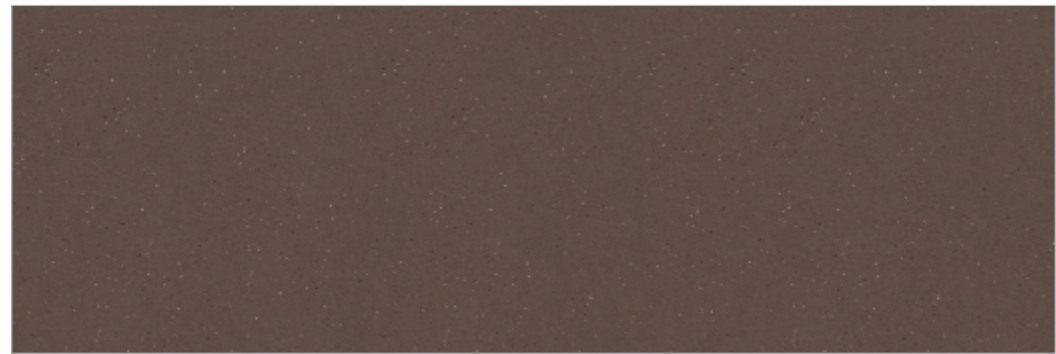

MAGIC CHOCO  
(Polish)

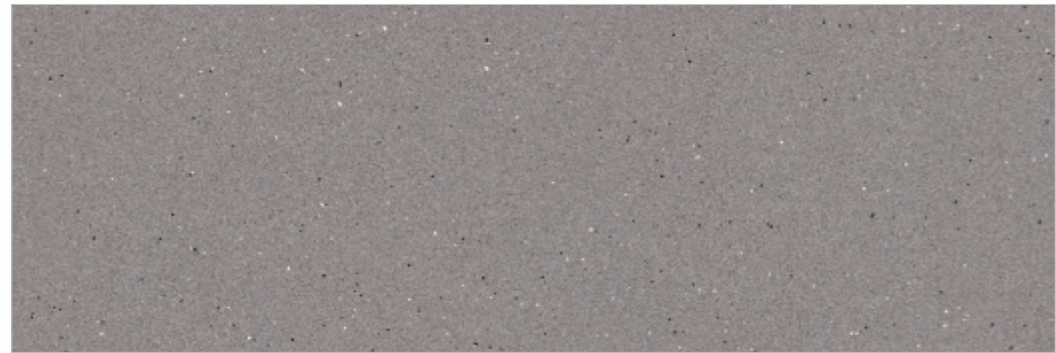

MAGIC GREY  
(Polish)

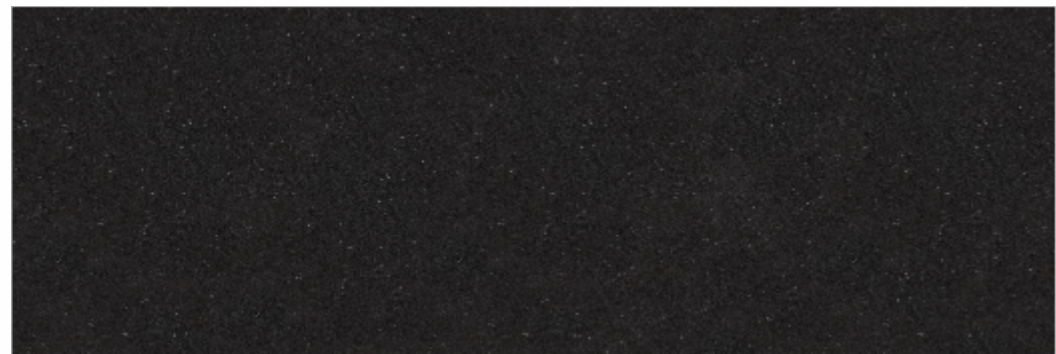

MAGIC NERO  
(Polish)



DOLCE BIANCO  
(Polish)



DOLCE NERO  
(Polish)



RECEPTION TABLE - DOLCE NERO

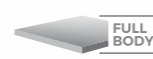

FULLBODY



GRIS (Polish) | GRIS MATT (Matt)



FULLBODY



BROWN (Polish) | BROWN MATT (Matt)



FULLBODY



DIAMOND NERO (Polish)

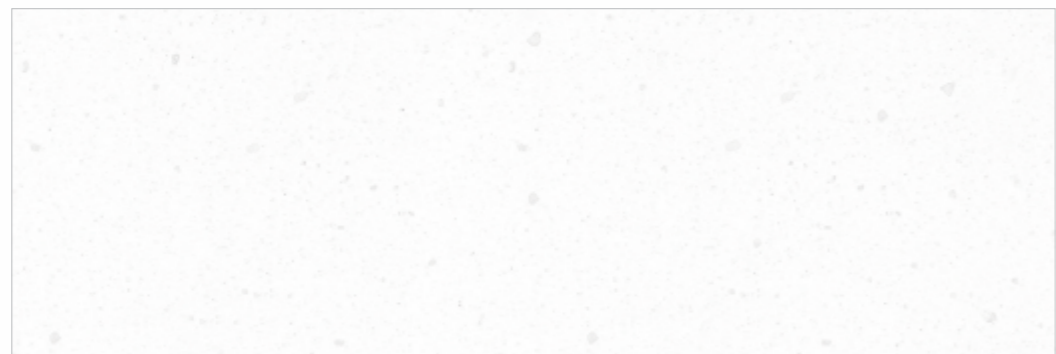

FULLBODY



LINOLEUM BIANCO (Polish)

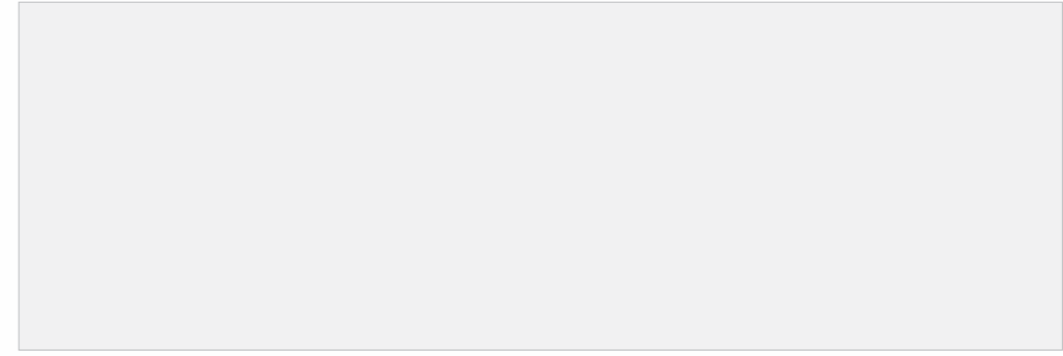

GLAZED BODY



PEARL BIANCO (Polish)

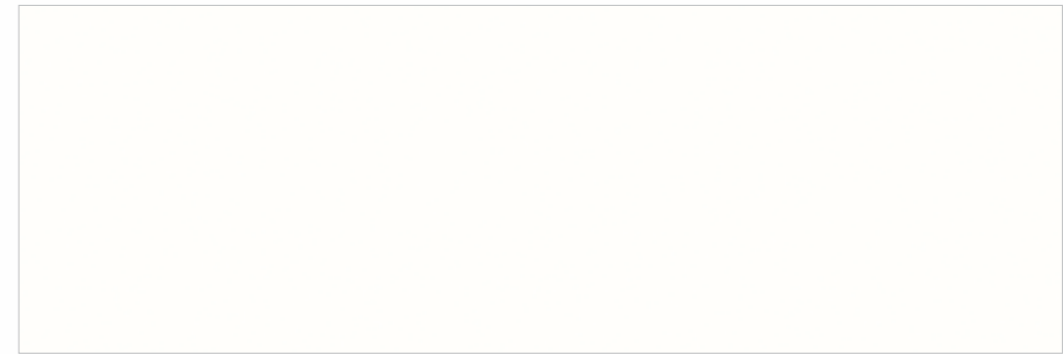

GLAZED BODY



SNOW WHITE (Polish)



GLAZED BODY



NERO (Polish)



TABLE TOP - SNOW WHITE



TIA BIANCO  
(Carving)

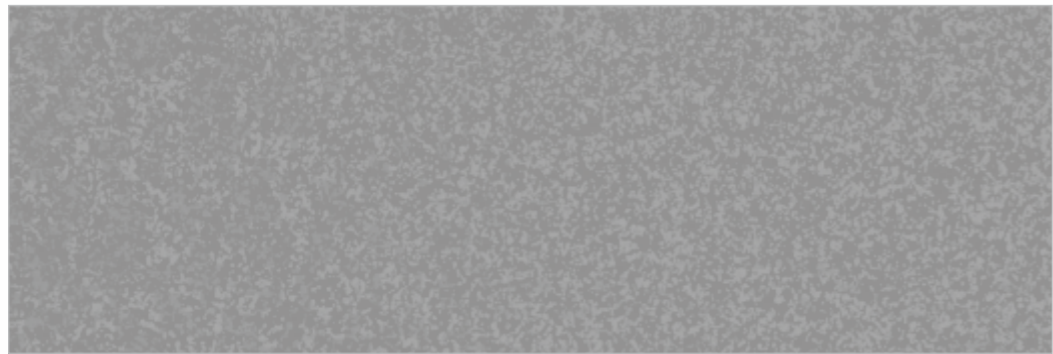

TIA GREY  
(Carving)

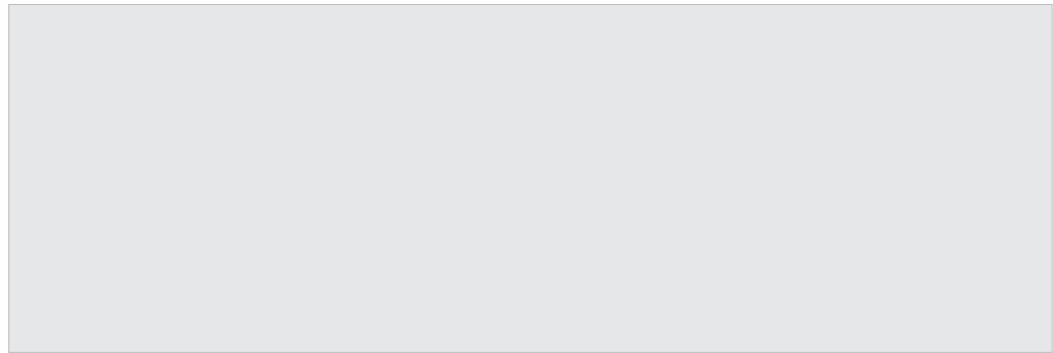

TIA NERO  
(Carving)



OFFICE TABLE - TIA NERO

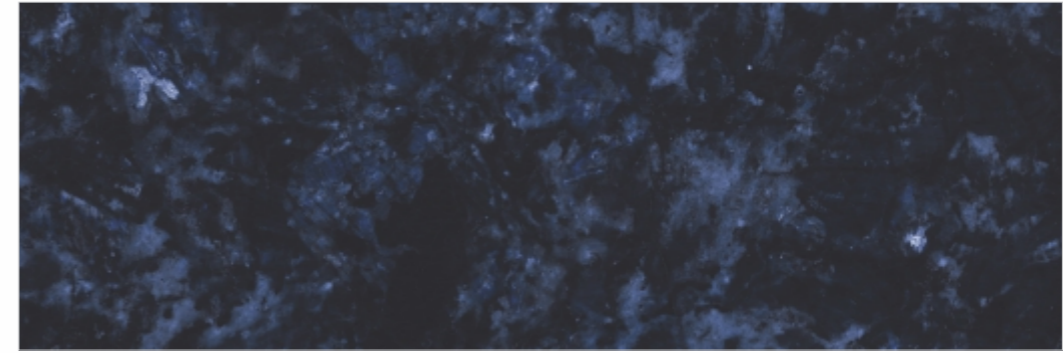

VOLGA BLUE  
(High Gloss)

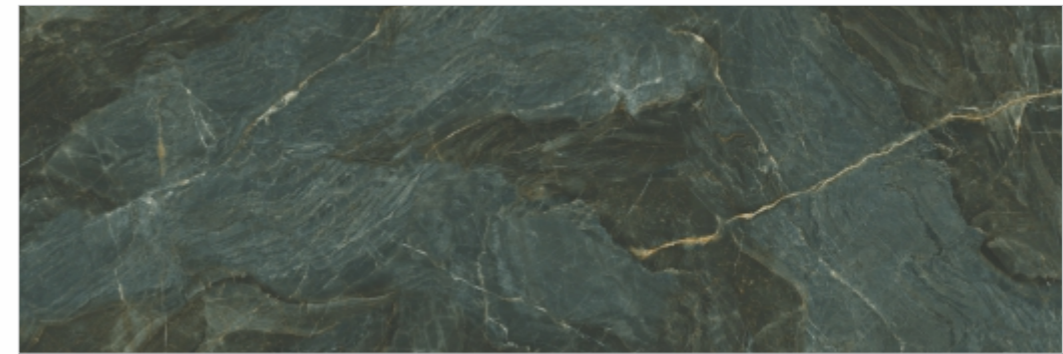

MARMO VERDE  
(High Gloss)



WALL - MARMO VERDE

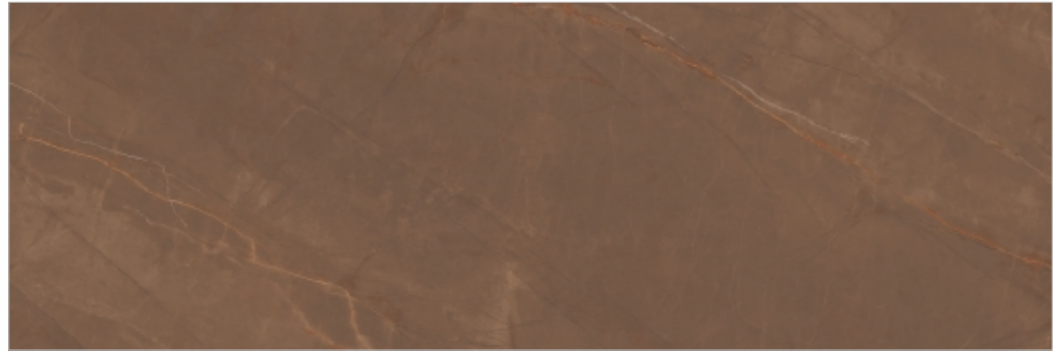

ARMANI BROWN  
(High Gloss)

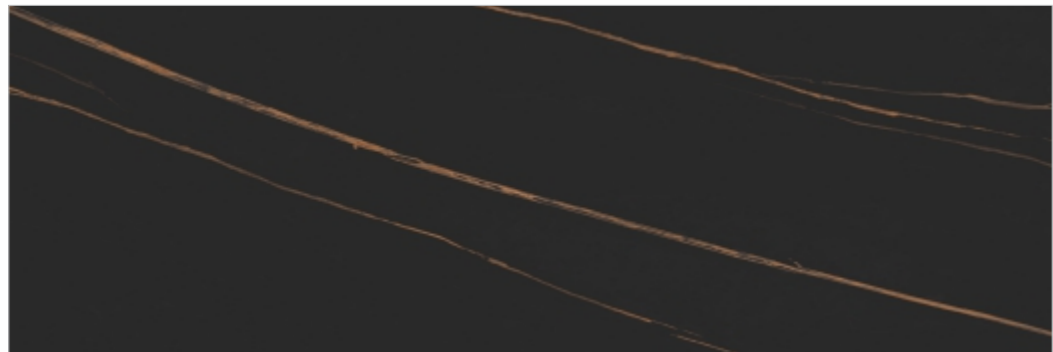

SAN LORENZO  
(High Gloss)



WALL - SAN LORENZO



LASCA BIANCO  
(Polish)



CALACATA NUEVO  
(Polish)

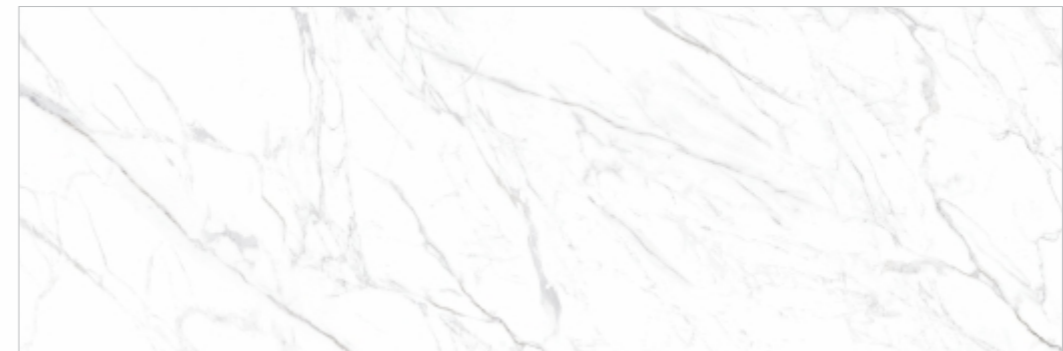

STATUARIO VIENNA  
(Polish)

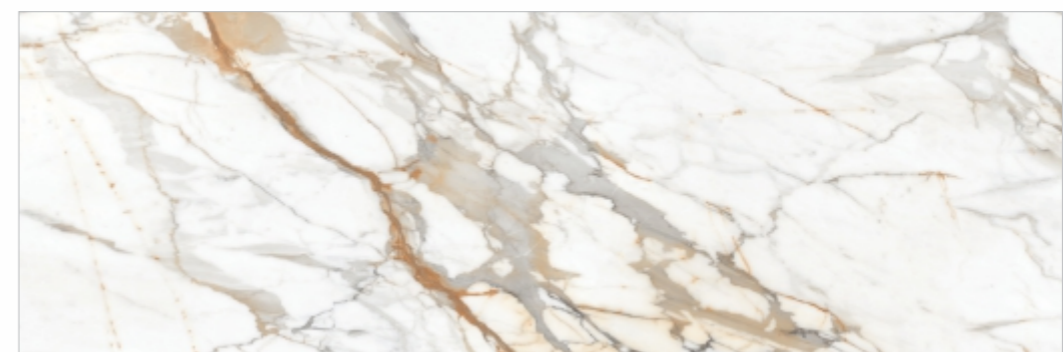

CALACATA GOLD  
(Polish)



CREMA MARFIL  
(Polish)



SILVER RIO  
(Polish)



WALL & FLOOR - CREMA MARFIL



CALACATA FRESCO  
(Manteca)



SILVER FERRO  
(Manteca)



SHOWROOM FLOOR - SILVER FERRO



SIETE BIANCO  
(Polish)

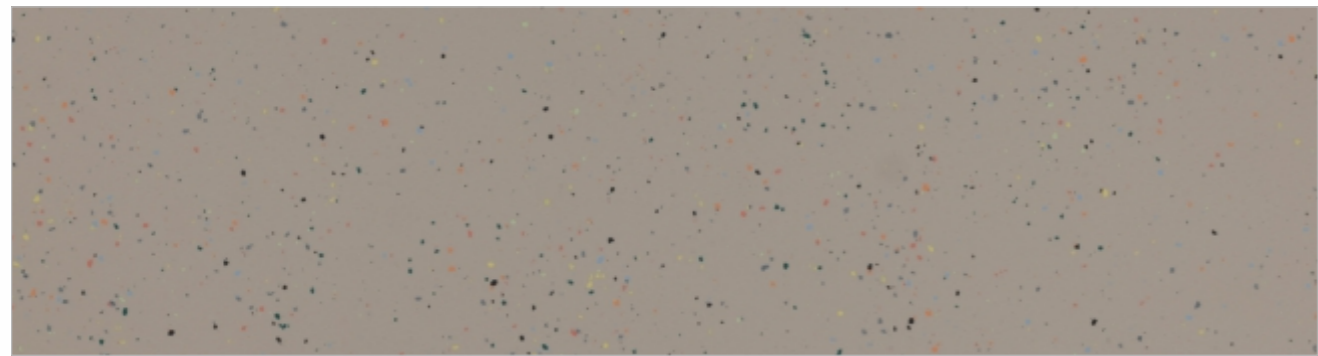

SIETE BROWN  
(Polish)



BATHROOM WALL & FLOOR - SIETE BIANCO

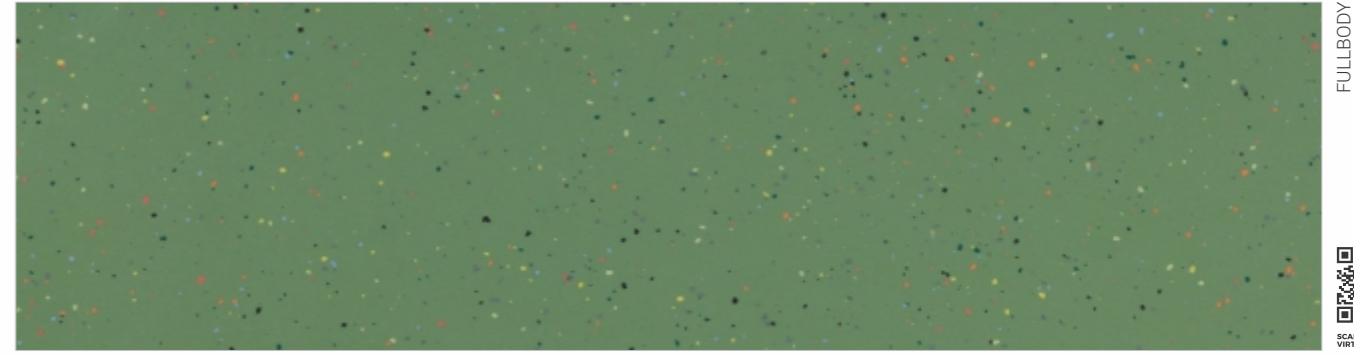

SIETE VERDE  
(Polish)

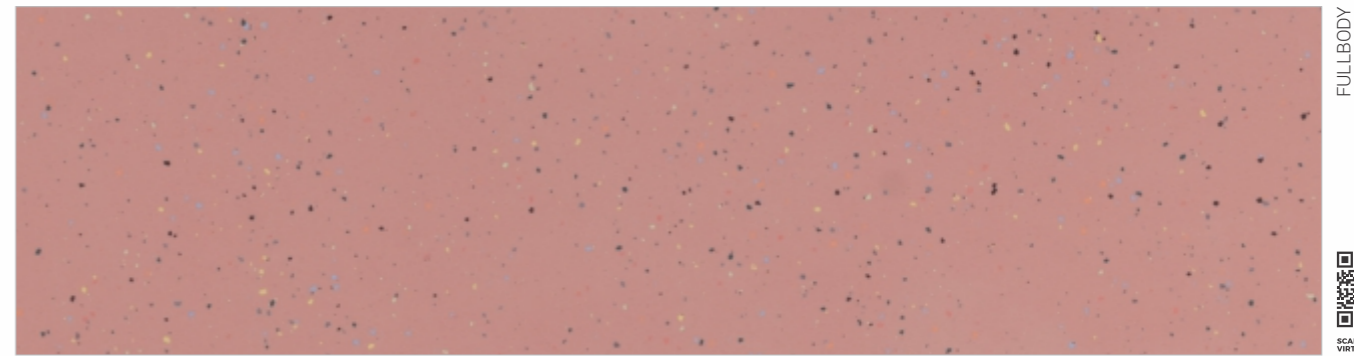

SIETE ORANGE  
(Polish)



BATHROOM WALL - SIETE ORANGE

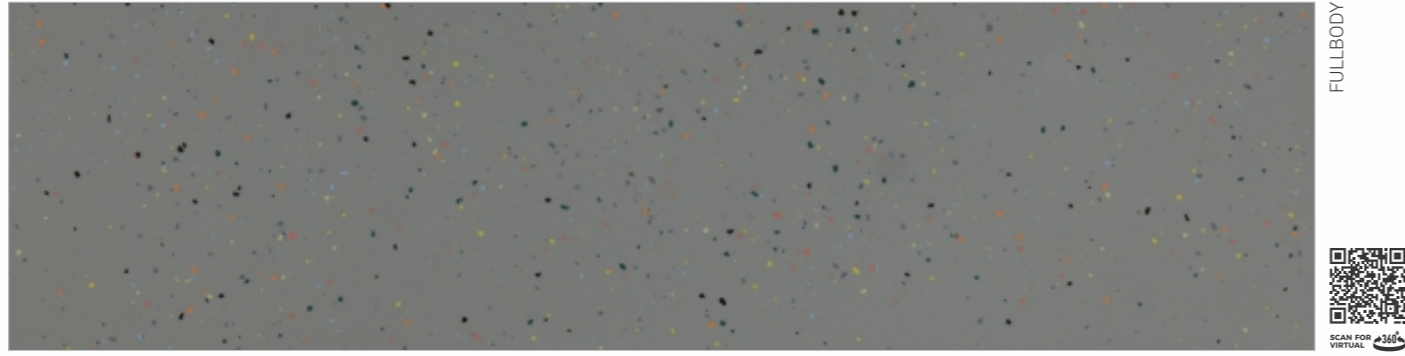

SIETE GRIS  
(Polish)

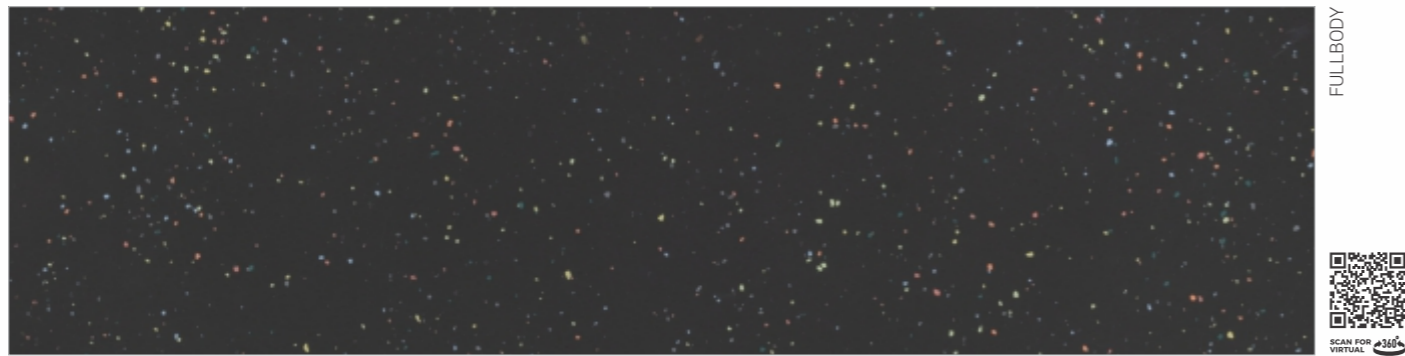

SIETE NERO  
(Polish)



BASIN COUNTER & TABLE TOP - SIETE GRIS.



CENTEZZA FIOCHI CREMA (Polish) | CENTEZZA FIOCHI CREMA-MATT (Manteca)



CENTEZZA FIOCHI BROWN (Polish) | CENTEZZA FIOCHI BROWN-MATT (Manteca)

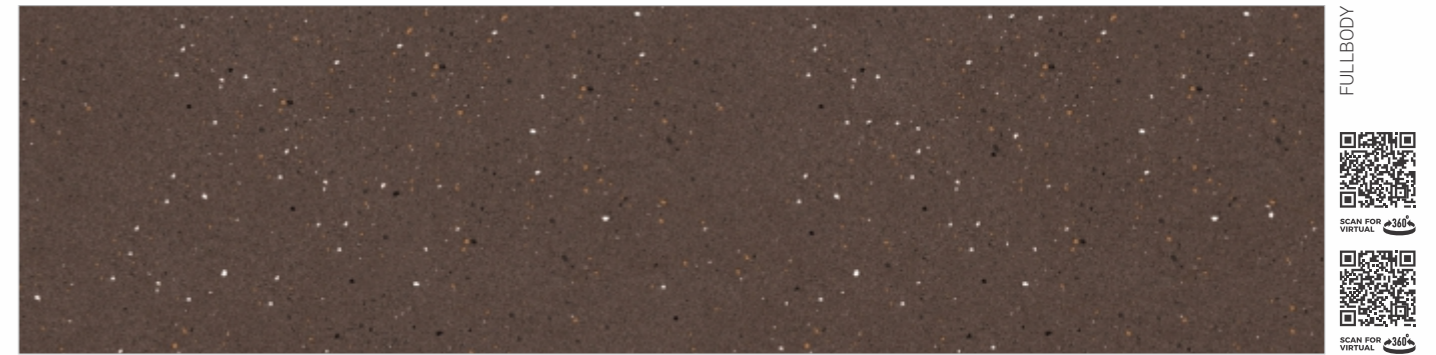

CENTEZZA FIOCHI CHOCO (Polish) | CENTEZZA FIOCHI CHOCO-MATT (Manteca)



RECEPTION TABLE - CENTEZZA FIOCHI CHOCO

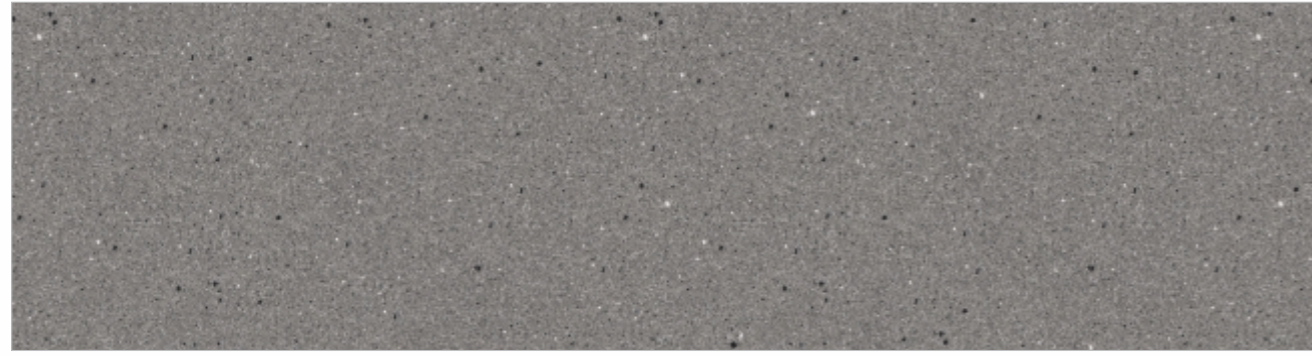

FULL BODY



CENTEZZA FIOCHI GRIS (Polish) | CENTEZZA FIOCHI GRIS-MATT (Manteca)

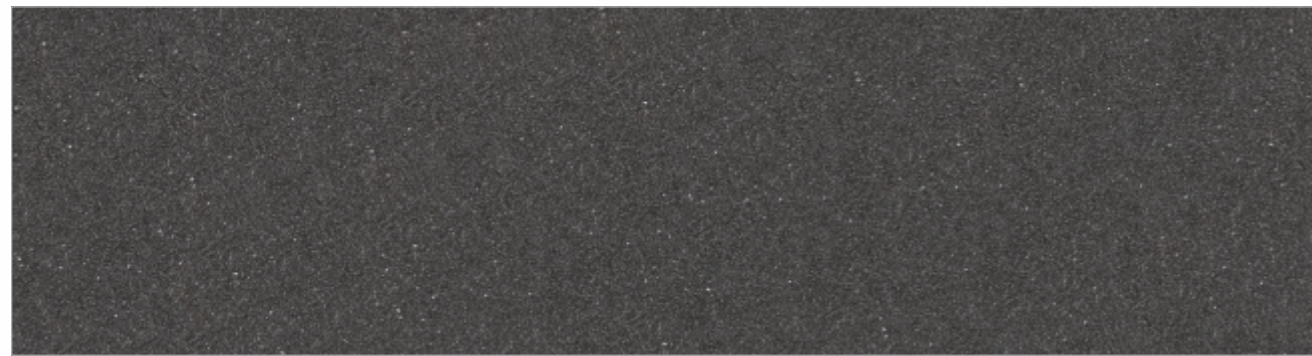

FULL BODY



CENTEZZA FIOCHI NERO (Polish) | CENTEZZA FIOCHI NERO-MATT (Manteca)



TABLE TOP - CENTEZZA FIOCHI NERO

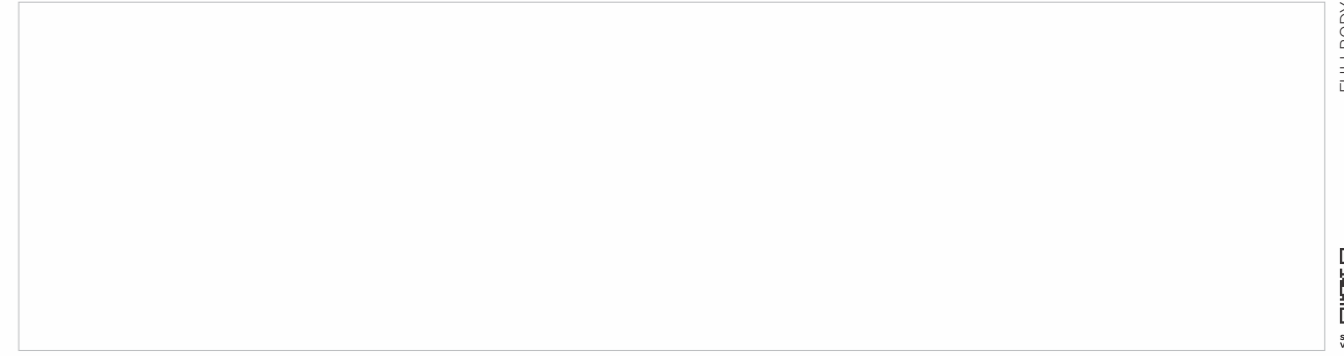

FULL BODY



GLACIER BIANCO (Polish)



FULL BODY



GOLDEN BROWN (Polish)



FULL BODY



GRIS (Polish)



FULL BODY



DIAMOND NERO (Polish)

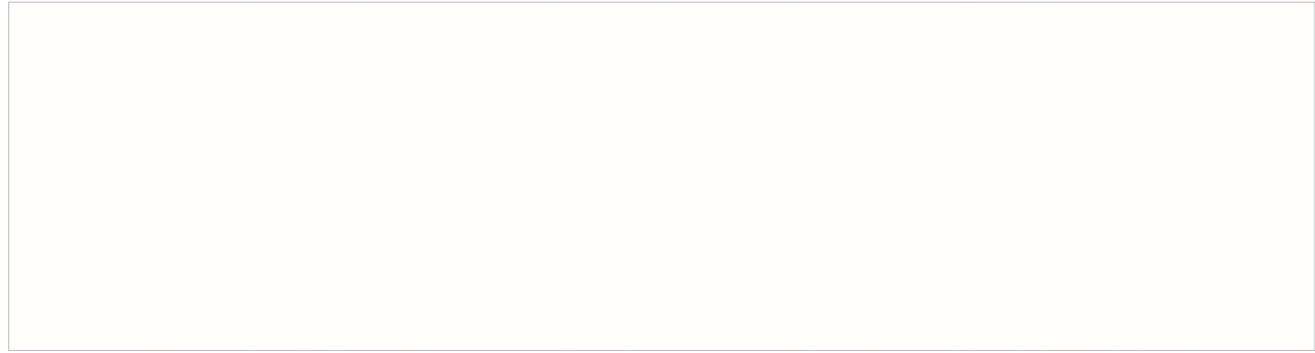

GLAZED BODY



SNOW WHITE  
(Polish)



GLAZED BODY



NERO  
(Polish)



TABLE TOP - SNOW WHITE



STATUARIO VENATO  
(Polish)

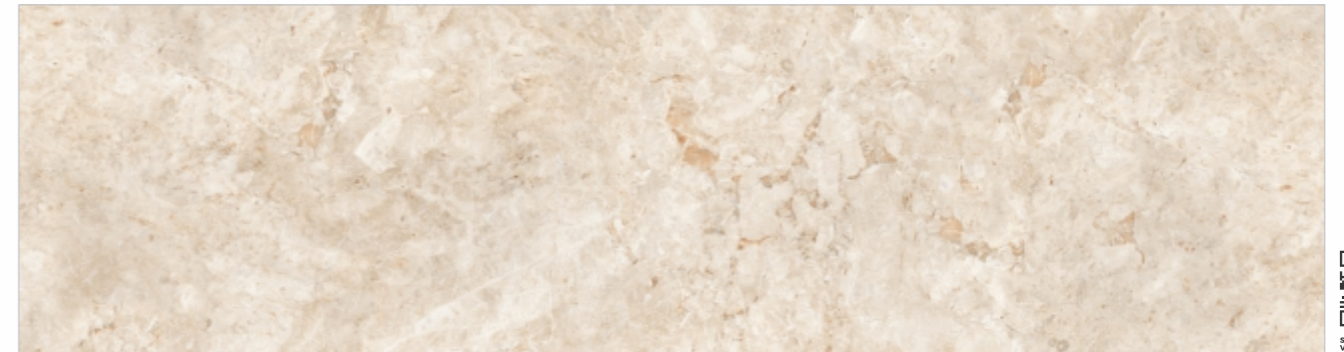

BRESCIA NATURAL  
(Polish)

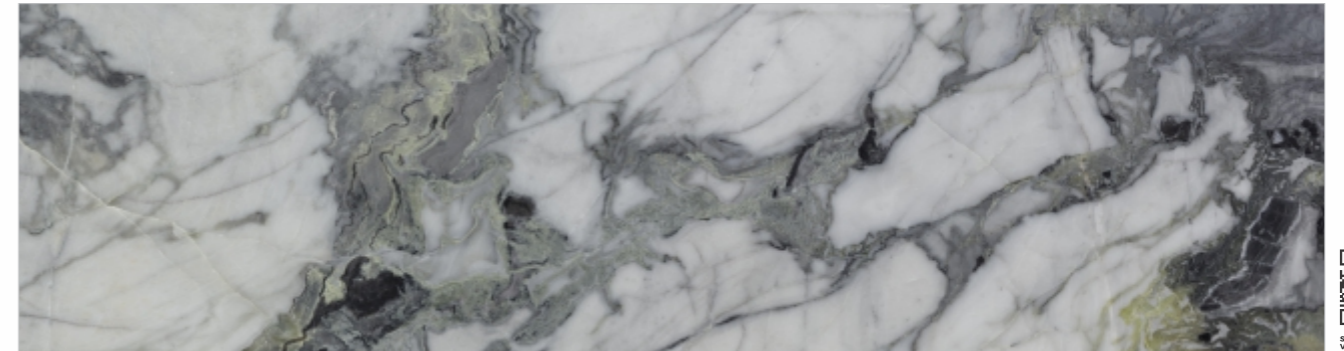

JADE GREEN  
(Polish)



KITCHEN ISLAND - STATUARIO VENATO

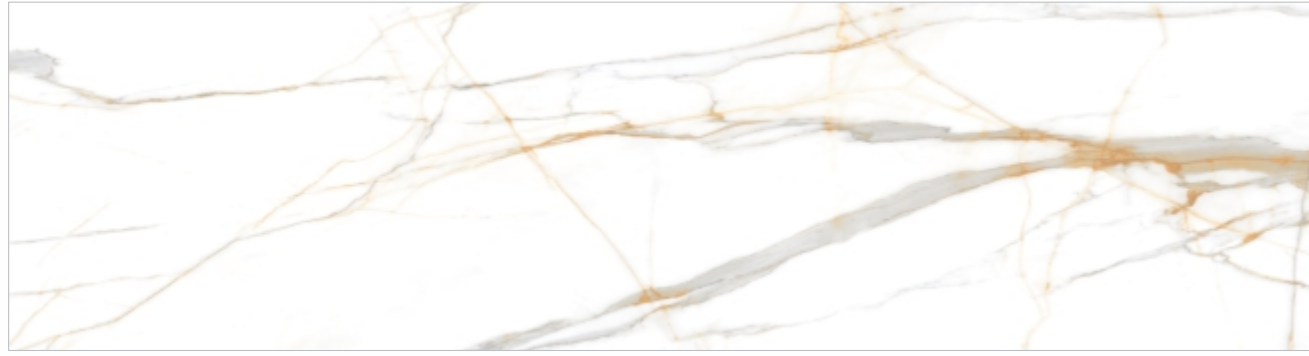

CALACATA AURIC  
(Manteca)



SANTORINI BIANCO  
(Manteca)



LAUREN NERO  
(Manteca)



KITCHEN ISLAND -  
LAUREN NERO



BRESCIA BEIGE  
(Manteca)

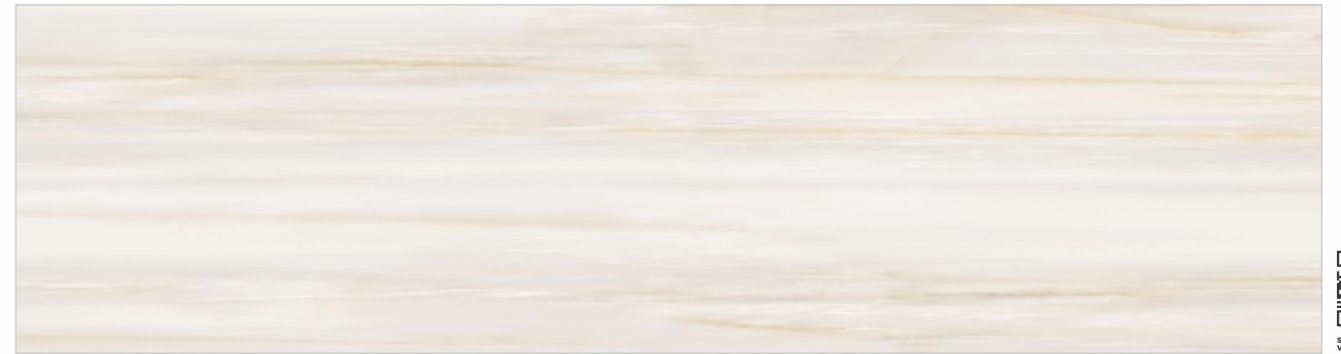

BIANCO CHROMO  
(Manteca)



BASIN COUNTER - BIANCO CHROMO

## TECHNICAL SPECIFICATION FOR GVT

CHARACTERISTICS	Requirement as per ISO 13006:2018 Gr Bla E < 0.5%	Requirement as per IS 15622:2017 Gr Bla E < 0.08%	MEAN VALUE OF AGL	METHOD OF TESTING
<b>Regulatory Properties</b>				
Deviation In Length & Width	± 0.3%, ± 1.0mm	± 0.1%	<± 0.1%	ISO 10545 Part-2 IS 13630 Part-1
Deviation In Thickness	± 5.0%, ± 0.5mm	± 5.0%	± 4.0%	ISO 10545 Part-2 IS 13630 Part-1
Straightness of Edge	± 0.3%, ± 0.8mm	± 0.1%	<± 0.1%	ISO 10545 Part-2 IS 13630 Part-1
Rectangularity	± 0.3%, ± 1.5mm	± 0.1%	± 0.1%	ISO 10545 Part-2 IS 13630 Part-1
Surface Flatness	± 0.4%, ± 1.8mm	± 0.5%	± 0.2%	ISO 10545 Part-2 IS 13630 Part-1
Surface Quality	Min. 95% of Tiles shall be free from visible defects that would impair the appearance of a major area of the tiles	Min. 95% of Tiles shall be free from visible defects that would impair the appearance of a major area of the tiles	Min. 95% of Tiles shall be free from visible defects that would impair the appearance of a major area of the tiles	ISO 10545 Part-2 IS 13630 Part-1
Glossiness	-	-	90-95 in Glossy surface	Glossmeter

### Physical & Thermal Properties

Water Absorption % By Wt.	< 0.5, Ind. 0.6 Max.	< 0.08, Ind. 0.1 Max.	< 0.08%	ISO 10545 Part-3 IS 13630 Part-2
Flexural Strength (MOR) In N/mm <sup>2</sup>	Avr. 35, Ind. Min. 32	Avr. 35, Ind. Min. 32	Min. 40 N/mm <sup>2</sup>	ISO 10545 Part-4 IS 13630 Part-6
Breaking Strength in N	1300 N Min.	1300 N Min.	Min. 1300 N	ISO 10545 Part-4 IS 13630 Part-6
Bulk Density (gm/cc)	2.0 Min.	2.2 Min.	Min. 2.25	ISO 10545 Part-3 IS 13630 Part-2
Resistance to Surface Abrasion	Manufacturer to State Class	PEI II Min.	PEI III Min.	ISO 10545 Part-7 IS 13630 Part-11
Co-efficient of Linear Thermal Expansion from ambient temp to 100°C (K-1)	9x10 <sup>-6</sup> Max.	6x10 <sup>-6</sup> Max.	< 6x10 <sup>-6</sup>	ISO 10545 Part-8 IS 13630 Part-4
Thermal Shock Resistance	10 Cycles Min.	10 Cycles Min.	No Damage after 10 Cycles min.	ISO 10545 Part-9 IS 13630 Part-5
Moisture Expansion in mm/M	Test Method Available	0.02 Max.	Nil	ISO 10545 Part-10 IS 13630 Part-3
Crazing Resistance	Required	4 Cycles at 7.5 bar Min.	Resistance	ISO 10545 Part-11 IS 13630 Part-9
Frost Resistance	Resistance	Resistance	Resistance	ISO 10545 Part-12 IS 13630 Part-10
Moh'S Scratch Hardness	Min. 5	Min. 5	Min. 5	EN 101/IS 13630 Part-13

### Chemical Properties

Resistance To House hold Chemicals	No Damage	Min. Class AA	Class AA	ISO 10545 Part-13 IS 13630 Part-8
Resistance To Acids & Alkalis (Except HF Acid)	No Damage	Min. Class AA	Class AA	ISO 10545 Part-13 IS 13630 Part-8
Stain Resistance	Min. Class 3	Min. Class 1	Resistance	ISO 10545 Part-14 IS 13630 Part-8

## PACKING SPECIFICATION

Size (mm)	Thickness (mm)	Weight (Kg.)	No. of Tiles / Set	Area Sq. mtr./ Box
1200x1800mm	9 mm	92.0 kgs.	2 pcs.	4.32m <sup>2</sup>
800x1600mm	9 mm	53.0 kgs.	2 pcs.	2.56m <sup>2</sup>
800x3000mm	15 mm	85.0 kgs.	1 pcs.	2.40m <sup>2</sup>
800x2400mm	15 mm	70.0 kgs.	1 pcs.	1.92m <sup>2</sup>

## TECHNICAL SPECIFICATION FOR FULL BODY



CHARACTERISTIC	STANDARD AS PER ISO13006:2018/ EN14411 Gr.Bla	STANDARD AS PER IS 15622:2017 Gr.Bla	MEAN VALUE OF AGL	METHOD OF TESTING
<b>Regulatory Properties</b>				
Deviation in Length and Width	±0.30 % (±1.00 mm)	±0.10 %	± 0.10 %	ISO 10545-2/IS 13630-1
Deviation in Thickness	±5.0 % (± 0.50 mm)	±5.0 %	± 5.0 %	ISO 10545-2/IS 13630-1
Straightness in Side	±0.30 % (± 0.80 mm)	±0.10 %	± 0.10 %	ISO 10545-2/IS 13630-1
Rectangularity	±0.30 % (±1.50 mm)	±0.10%	± 0.10 %	ISO 10545-2/IS 13630-1
Surface Flatness Central Curvature	±0.40 % ( ± 1.80 mm)	±0.50 %	± 0.20 %	ISO 10545-2/IS 13630-1
Surface Flatness Edge Curvature	±0.40 % ( ± 1.80 mm)	±0.50 %	± 0.20 %	ISO 10545-2/IS 13630-1
Surface Flatness Warpage	±0.40 % (± 1.80 mm)	±0.50 %	± 0.10 %	ISO 10545-2/IS 13630-1
Surface Quality	>95% defects free	>95% defects free	>95% defects free	ISO 10545-2/IS 13630-1
Small Color Difference (For Plain Colour)	ΔE <1.00	N.A.	ΔE <0.80	ISO 10545-16
Glossiness ( Polished)	As per Manufacturer	As per Manufacturer	≥ 90	Gloss Meter 60°
Glossiness (Satin)	As per Manufacturer	As per Manufacture	7 ≤ Gloss Value ≤ 25	Gloss Meter 60°

### Structural Properties

Water Absorption	≤0.50 %	≤0.080 %	≤0.080 %	ISO 10545-3/IS 13630-2
Bulk Density	As per Manufacturer	Min 2.20 g/cc	> 2.25 gm/cc	ISO 10545-3/IS 13630-2

### Massive Mechanical Properties

Modulus of Rupture	Min. 35.0 N/mm <sup>2</sup>	Min. 35.0 N/mm <sup>2</sup>	Min. 40.0 N/mm <sup>2</sup>	ISO 10545-4/IS 13630-6
Breaking Strength Thickness ≥7.5 mm	Min 1300.0 N	Min 1300.0 N	Min 6000.0 N	ISO 10545-4/IS 13630-6

### Surface Mechanical Properties

Mohs Hardness #	As per Manufacturer	Min. 5	Polished Min 4**/ Satin & Posh Min 6	BS EN 15771/IS 13630-13
Surface Abrasion Resistance #	As per Manufacturer	Min. Class II	Polished Min II**/ Satin & Posh Min III	ISO 10545-7/IS 13630-11

### Thermal Hygrometric Properties

Moisture Expansion	Max 0.06% (0.6 mm/m)	Max 0.02 mm/m	Max 0.02 mm/m	ISO 10545-10/IS 13630-3
Thermal Expansion(COE) at 100°C	As per Manufacturer	Max. 6.0 x 10 <sup>-6</sup>	Max. 6.0 x 10 <sup>-6</sup>	ISO 10545-8/IS 13630-4
Thermal Shock Resistance	Min 10 Cycle	Min 10 Cycle	Min 10 Cycle	ISO 10545-9/IS 13630-5
Impact Resistance(COR) #	Min. 0.55	Min 0.55	Min 0.55	ISO 10545-5/IS 13630-14
Frost Resistance	As per Manufacturer	As per Manufacturer	Frost Proof	ISO 10545-12/IS 13630-10
Crazing Resistance at 7.5 bar	4 Cycle	4 Cycle	4 Cycle	ISO 10545-11/IS 13630-9

### Chemical Properties

Resistance to Staining Glazed	Min. Class 3	Min Class 1	Min. Class 3/Min. Class 1	ISO 10545-14/IS 13630-8
Resistance to Household Chemicals & Swimming Pool Salts Glazed	Min Class GB	Min Class AA	Min Class GB/Min Class AA	ISO 10545-13/IS 13630-8
Resistance to Low Concentrate Acid and Alkalis Glazed	As per Manufacturer	As per Manufacturer	Min Class GLB***/ Min Class A***	ISO-10545-13/IS 13630-8
Resistance to High Concentrate Acid and Alkalis Glazed	As per Manufacturer	As per Manufacturer	Min Class GHB***/ Min Class A***	ISO-10545-13/IS 13630-8

### Safety Properties

Skid Resistance - (DCOF-WET PENDULUM)##	As per Manufacturer	As per Manufacturer	Glossy ≥P0,Satin, Posh ≥P1	BS 7976-2
Slip Resistance -Satin/Posh (DCOF- R Value )##	As per Manufacturer	As per Manufacturer	R9 to R10	DIN 51130
Lead and Cadmium release	As per Manufacturer	N.A.	Does not yield Pb &Cd	ISO-10545-15

\* Whichever is Lower | \*\* With nano technology (Polished Vitrified tiles) Depending on Application area (low or high intensity of traffic)  
\*\*\* Except Hydrofluoric Acid & it's compound | # Tiles Intended for use on floor | ## For floor tiles, as per customer requirement

## PACKING SPECIFICATION

Size (mm)	Thickness (mm)	Weight (Kg.)	No. of Tiles / Set	Area Sq. mtr./ Box
800x1600mm	9 mm	53.0 kgs.	2 pcs.	2.56m <sup>2</sup>
800x3000mm	15 mm	85.0 kgs.	1 pcs.	2.40m <sup>2</sup>
800x2400mm	15 mm	70.0 kgs.	1 pcs.	1.92m <sup>2</sup>

## SLAB LAYING

### Tools suggested for Laying

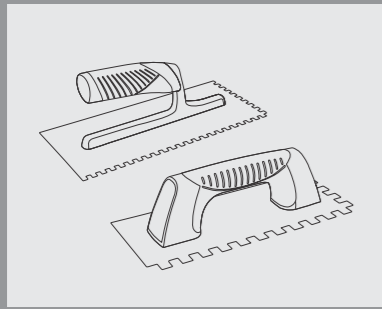

3mm & 10mm trowel

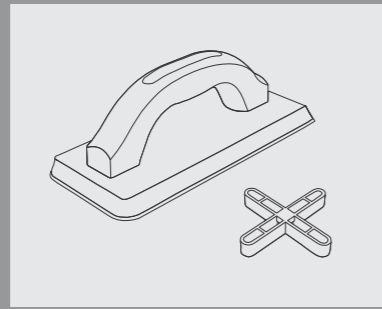

Rubber trowel & Spacers

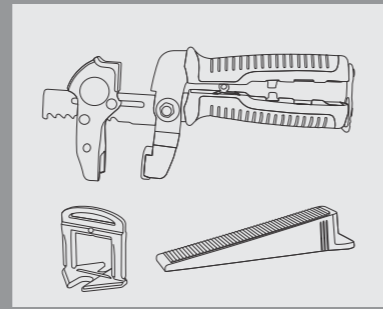

Device for plate's pulling over and Leveling wedges & clips

## SLAB LAYING INSTRUCTIONS

Check the laying substrate. Make sure it is clean, mature, and homogeneous with no cracks.

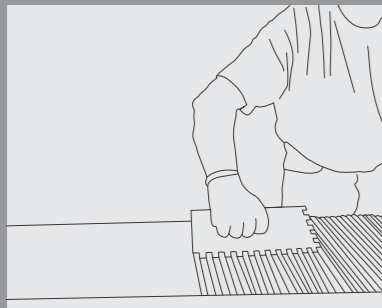

Apply adhesive onto the back of the slab with a 3mm trowel in one direction only.

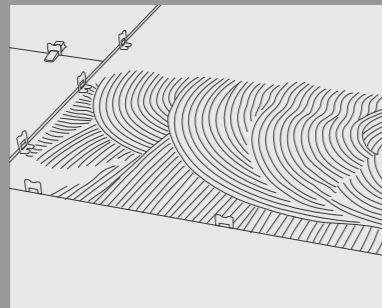

Apply adhesive onto the floor substrate at the same time while applying on the slab with a 15mm U-notch or 19mm V-notch trowel in the same direction as the slabs.

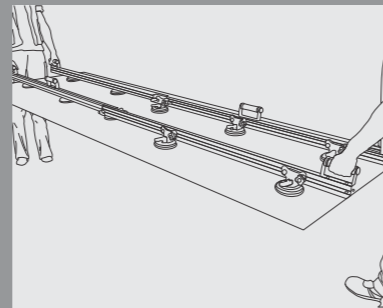

Position the slab on the adhesive bed with a sucker frame with adjustment of a minimum of 3mm joint.

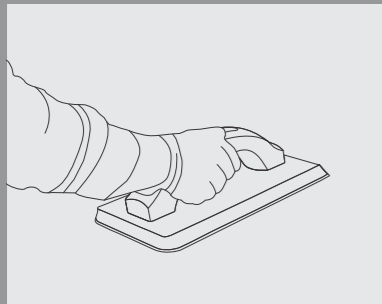

Tap the slab from the center to the edges with a rubber trowel to expel air. Make sure air is expelled and there is no bubble between the slab and the substrate.

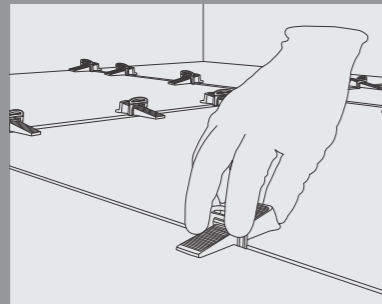

Complete the laying of the slab with a suitable sealant while keeping a 3mm joint through spacers. The special device of pulling over the slabs can be used for easy laying and spacing.

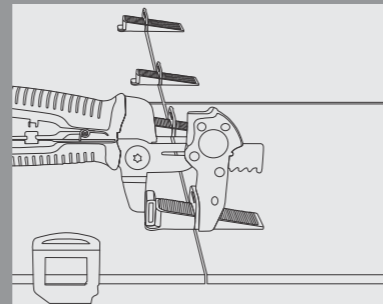

Level the wedges at each linear meter of the slab.

## SLAB EDGE POSSIBILITIES

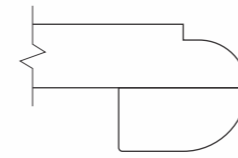

1-1/2" Dupont Bullnose

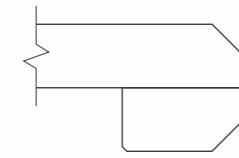

1-1/2" Pencile Edge

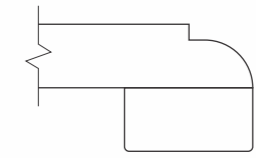

1-1/2" Dupont Square

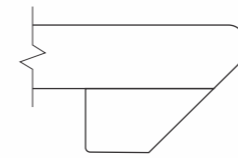

1-1/2" Revers Bevel

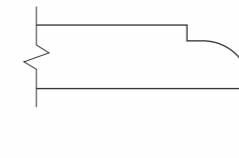

3/4" Dupont Demi

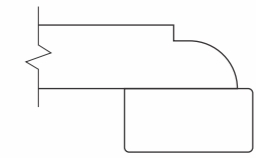

1-1/2" Dupont Step Square

## CLEANING & MAINTENANCE

High-quality raw materials, rigorous production parameters, and world-class technology at AGL make the exclusive offering nonporous and thus no dust or deposited waste penetrates the surface.

The no-maintenance surfaces require only a damp cloth for cleaning.

Routine and recurring cleaning spotlights the aesthetic features of the surfaces and keeps the surfaces shining.

For cleaning contamination and stains caused by some common food and other material follow the table below:

TYPE OF STAIN	CHEMICAL PRODUCT	EXAMPLE
Grease	Alkaline - Solvent	Detergent
Oil	Solvent	Ammonia, Baking Soda
Ink	Oxidant - Solvent	Alcohol, Liquid Bleach, Nail Paint Remover
Rust	Acid	Hydrochloric Acid, Vinegar, Red Harpic
Lime	Acid	Descaling Reagent, Hydrochloric Acid
Cement	Acid	Hydrochloric Acid
Wine	Alkaline	Ammonia, Liquid Bleach
Coffee	Alkaline - Solvent	Ammonia, Liquid Bleach
Rubber	Solvent	Alcohol, Thinner
Plaster	Acid	Hydrochloric Acid
Candle Wax	Solvent	Alcohol, Thinner
Iodine	Oxidant	Liquid Bleach
Blood	Oxidant	Liquid Bleach
Ice Cream	Alkaline	Liquid Bleach

**Note:** It is recommended that any kind of stain needs to get clean immediately / as soon as possible.

## SLAB COUNTERTOP CUTTING

### Preparation:

Check the straightness of the cutting bench, and its level, and ensure it is free from debris. Check for proper and enough support for the slab and its cutting.

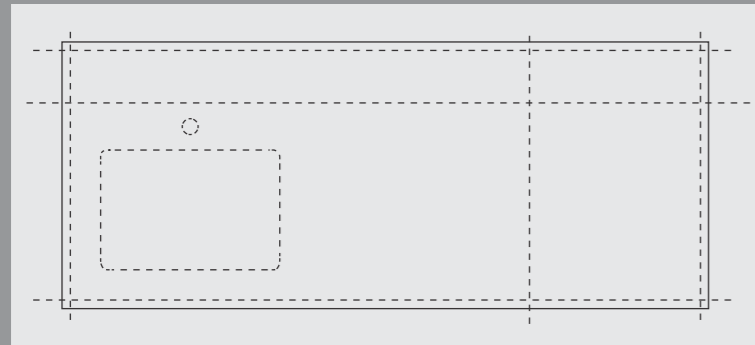

### Waterjet Cutting

The cut should begin and go off the slab while cutting 3/4" perimeter from 1/2" and 3/4" slabs using waterjet.

**Steps:** • Make a perimeter cut of a minimum of 2 cm. (Only for 12mm and 20mm slab) • Make the cutting • prepare and refine the cutouts • Make sure of the radius of 3mm for all inner corners

We recommend radiuses of more than 3mm for kitchen countertop cutouts which facilitates firmer countertops.

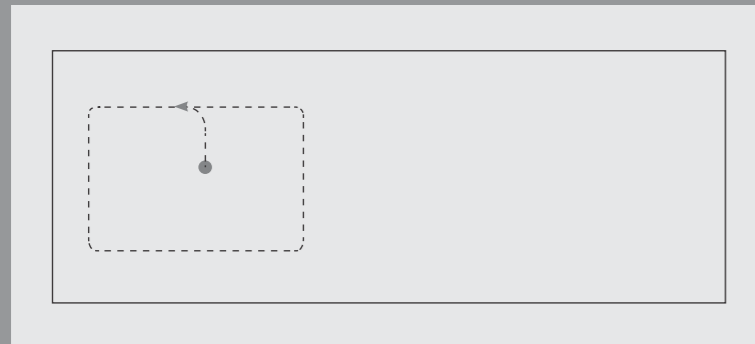

**Important:** • The perimeter cut of the slab releases stress and may be used as a final cut for the final product. • The lower pressure of the drill and on the drill is recommended for drilling holes. • For cutouts begin cutting at an internal point of the cutout and get closer to the perimeter.

### Gap between cutouts

For multiple cutouts on a countertop, the minimum distance between cutouts whether small or big, and the edge must be kept at least 5cm.

**Important:** All cut corners must have a minimum radius of 3mm and never should have 90-degree angles. A radius of 3mm facilitates firmer countertops as shown below:

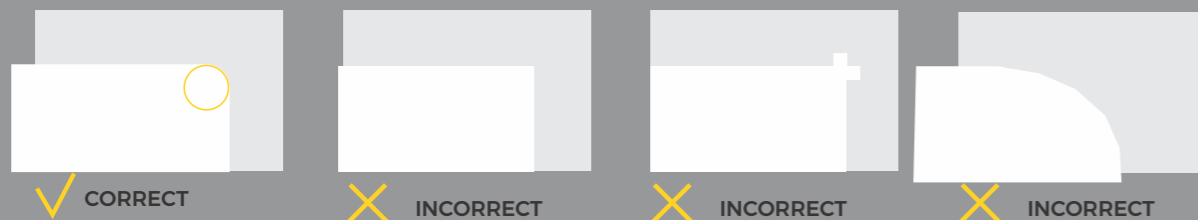
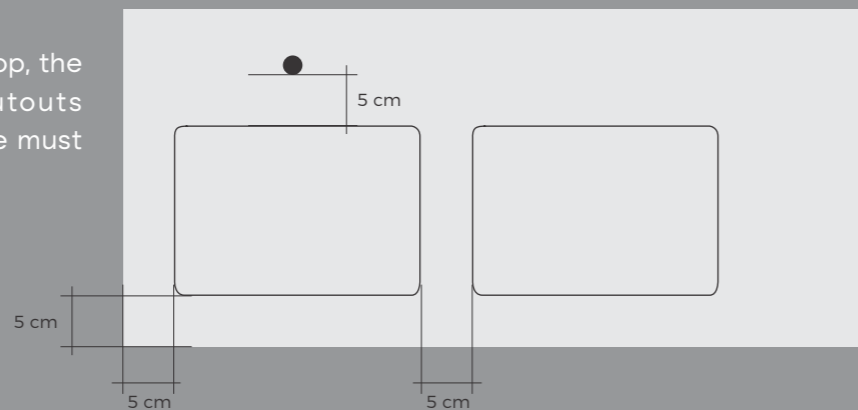

Unbalanced weights are not strictly not recommended



## Corporate Office & Branches



AGL'S BIGGEST LUXURY TILE ARCADE AHMEDABAD

### GUJARAT

- **Corp. Office - Ahmedabad**  
**ASIAN GRANITO INDIA LTD.**  
202, Dev Arc, Opp. Iskon Temple,  
S. G. Highway, Ahmedabad - 380 015  
Gujarat (INDIA)  
Phone: +91 79 66125500/698  
Toll Free: 1800 123 3455  
E-mail: info@aglasiangranito.com
- **Display Centre - Ahmedabad**  
**AGL Luxury Tile Arcade**  
S.G. Highway, Nr. Gota Cross Road,  
Beside Gota over bridge, Ahmedabad - 382481.  
Mobile: 98258 03713 / 99099 29920  
E-mail: asianworld.amd@aglasiangranito.com

- **AGL Office - Morbi**  
B - 26, Parshwanath Complex-1  
Opp. kuber Cinema, 8-A National Highway,  
Lalpar Road, Morbi - 363642.  
Mobile: 9825802077  
E-mail: aglmorbi@aglasiangranito.com

- **AGL Export House - Morbi**  
Ch-5, Eden Ceramic City,  
Opp.Honest Hotel, National Highway,  
Lalpar Road Morbi - 363642.  
Mobile: 99799 90591  
E-mail: exportmorbi@aglasiangranito.com

### RAJASTHAN

- **AGL Office - Jaipur**  
Lower Ground, D-5, Vaishali Nagar,  
Jaipur, Rajasthan - 302021  
Mobile: 80085 03660 / 93144 39930

### MADHYA PRADESH

- **AGL Office - Indore**  
3rd Floor, Plot No 101, WB Scheme No. 94,  
Sector - B, Opp. HDFC Bank, Nr. Bombay Hospital,  
Indore - MP - 452010  
Mobile: 99092 62533 / 73140 06670  
E-mail: acctindore@aglasiangranito.com

### MAHARASHTRA

- **AGL Display Centre - Mumbai**  
A- 402, Citi Point, Nr. kohinoor Hotel,  
Opp. ICICI Bank, J.B. Nagar,  
Chakala Metro Station, Andheri (East),  
Mumbai - 400 059.  
Mobile: 93214 95229  
E-mail: mumbaishowroom@aglasiangranito.com

- **AGL Display Center - Mumbai**  
**(Marblex & Grestek)**  
Gala Impecca, Gr. Floor, Mathuradas Vasanji Rd,  
Next to Caurtyard Marriott, J. B. Nagar,  
Kurla-Andheri Road, Andheri (East) - 400059  
Mobile : 7600098595

- **AGL Display Center - Pune**  
Capital Square, 1st & 2nd floor, Plot No.5,  
Nr. Laxminarayan Sweets, Industrial Estate,  
Mukund Nagar, Pune - 411037 Maharashtra.  
Mobile : 93717 65505

### TAMIL NADU

- **AGL Office - Trichy**  
Mark Diamond Residency, No-36,  
V O C Road, cantonment. Trichy - 620001  
Mobile: 90161 13976

- **AGL Office - Coimbatore**  
No .70, Dr. Alagappa Road, Tatabad.  
Coimbatore - 641 012  
Mobile: 90161 13976

### TELANGANA

- **AGL Display Centre - Hyderabad**  
**(Marblex & Grestek)**  
202 Kurve Elite, 2nd Floor, 8-3-833/58 & 47,  
Plot No. 58, Phase-1, Kamala Puri Colony Main Rd,  
Opp. Krishi Medows, Hyderabad-500073  
Mobile: 96420 00336 / 77779 15632  
E-mail: hydgv1@aglasiangranito.com

- **AGL Display Centre - Hyderabad**  
# 8-2-294/82,Plot No. 39, Road No. 5,  
JubileeHills Land Mark, Near Venkatagiri Bustop.  
(Dominos Pizza) Metro Pillar No.3,  
Hyderabad-500033  
Mobile: 96420 11146  
E-mail: hydshowroom@aglasiangranito.com

### KARNATAKA

- **AGL Display Centre - Bangalore**  
**Asian Granito India Ltd., Region Office**  
Brahmananda Court, No.37/17, Nr. ICICI Bank,  
Lalbagh Road, Bangalore - 560027 Karnataka  
Mobile: 81605 21204  
E-mail: bangloreshowroom@aglasiangranito.com

### KERALA

- **AGL Display Centre - Kochin**  
No.51/2910 D2 Adjacent To Bread World,  
Thykooodam Bridge Service Road,  
Vytila Kochin - 682019  
Mobile: 80866 61920 / 78618 09641  
E-mail: cochinshowroom@aglasiangranito.com

### WEST BENGAL

- **AGL Display Centre - Kolkata**  
5th Floor, Office No. 5A, PS SOLARIS Building,  
113/H, Opp. Flaming Hospital. Matheswartala Rd.  
Topsia. Kolkata 7000046.  
Mobile: 85840 65565  
E-mail: kolkattashowroom@aglasiangranito.com

### ODISHA

- **AGL Office - Odisha**  
Plot No-83/C, Jayadurga Nagar Bomikhal,  
Bomikhal, Cuttack-Puri Road,  
Bhubaneswar-751006  
Mobile: 78618 09594 / 78944 35425

### UTTAR PRADESH

- **AGL Display Centre - Noida**  
F-15, Ground Floor, Sector 8,  
Gautam Buddha Nagar,  
Noida - 201301 Uttar Pradesh  
Mobile: 7861806229

### PUNJAB

- **AGL Office - Chandigarh**  
CCC Chandigarh City Center, Block A 3rd Floor,  
Soho 325, Vip Road, Near Metro Zirakpur,  
Chandigarh Punjab-140603  
Mobile : 93163 13880 / 99882 22471